**COMMERCE SPECTRUM MANAGEMENT ADVISORY
COMMITTEE (“CSMAC”)**

**INTERFERENCE AND DYNAMIC SPECTRUM ACCESS
SUBCOMMITTEE**

FINAL REPORT
November 8, 2010

TABLE OF CONTENTS

<i>Executive Summary: Recommendations</i>	4
I. INTRODUCTION	15
II. SCOPE OF ISSUES EXAMINED	17
III. THE DELIBERATIVE PROCESS	18
IV. WORKING GROUP ISSUES AND RECOMMENDATIONS	18
A. SOURCES OF INTERFERENCE	19
1 Co-channel Interference	19
2. Inter-channel Interference	20
2.1 Out-of-Band Emissions	20
2.2 Adjacent Channel Interference and Receiver Selectivity	21
2.3 Spurious Responses	23
2.4 Intermodulation	24
2.5 Receiver Blocking (Overload)	26
3. Interference Scenarios	26
3.1 Transmit-Receive Scenarios	26
3.2 Near-Far Scenarios	27
4. Effect of Interference	28

B. INTERFERENCE MITIGATION TECHNIQUES & RECOMMENDATIONS	29
1. Guardbands Recommendations	30
1.1 Duplex Antenna Combining	32
1.2 Mobile-to-mobile Scenarios	33
1.3 Base-to-base Scenarios	34
1.4 Base-to-mobile and Mobile-to-base Scenarios	34
1.5 Summary:Guardbands as an Interference Avoidance Tool	35
2. Frequency Coordination Recommendations	36
3. Dynamic Spectrum Access Recommendations	38
3.1 Emerging Radio and Network Technologies	42
3.2 DSA Cognitive Radio and Sensing Technology	43
3.2.1 DSA Overview	43
3.2.2 DSA State of the Art	46
3.2.3 DSA Cognitive Radio & Sensing: Regulatory Situation	52
3.3 Database and Geolocation Approaches	53
3.3.1 Database Service Requirements	54
3.3.2 Centralization or Decentralization of Database Information and Calculations	55
3.3.3 Limiting Database Access to Certified Devices	56
3.3.4 Other Considerations	57
4. Harmonized Spectrum to Facilitate Grouping Services Recommendations	58

5. Allocation Decisions: Sharing Like Services/Mixing Disparate Services	59
6. Equipment Standards Recommendations	61
7. Enforcement Recommendations	66
7.1 Background	67
7.2 History	68
7.2.1 Factors to be Addressed	68
7.2.2 Case Studies	71
7.3 Recommendations	73
7.3.1 Streamlined Reporting/Enforcement	73
7.3.2 Increased Penalties for Violations	74
7.3.3 Increased Budgetary Resources for Monitoring & Enforcement	74
7.3.4 Shot Clock Timelines for Addressing Interference	75
7.3.5 Increased Assessment/Test-Bed Approach	75
7.3.6 Monitor Deployment of Systems Employing Opportunistic Sharing Techniques	75
V. CONCLUSION	77

Executive Summary: Recommendations

If government spectrum managers are to meet the ever increasing demand for spectrum from government and commercial entities, they must employ new spectrum sharing techniques and technologies. Employing effective interference mitigation techniques is essential to avoid interference and to bring a diverse array of services to the American public. Through the years, government agencies responsible for spectrum management successfully have employed a number of mechanisms to foster spectrum sharing and improve efficiency. Nonetheless, in an era of increased demand for spectrum, mechanisms that facilitate spectrum sharing will become a necessity.

The following summarizes the Interference Subcommittee's recommendations for the Commerce Spectrum Management Advisory Committee (CSMAC) to provide to the National Telecommunications and Information Administration (NTIA). Our focus is to identify techniques that have been successful in the past, but more importantly to provide guidance on new approaches to interference mitigation. Many of these techniques will require additional technical work and testing. Some technologies are not ready for widespread government or commercial applications. Nonetheless, it is important to outline a framework for approaching new technology. Where appropriate, we encourage the Department of Commerce and NTIA to make significant investments in these techniques in order to allow greater spectrum sharing without causing interference to incumbent services.

Before proceeding with specific recommendations, it is important to discuss the term "interference." As a general matter, the NTIA, the Federal Communications Commission (FCC) and other spectrum managing agencies have sought to avoid "harmful" interference. "Harmful interference" is a term used repeatedly in the Communications Act but not defined there. Different terms such as "disruptive interference" or "destructive interference" are sometimes employed. As a legal construct, they all involve the balancing of interests, where the potential service loss is balanced against the benefits of providing new service. In certain cases, this analysis involves an assessment of predictive models based on probabilistic reception and interference analysis. Moreover, the amount of interference that may be tolerated before it is considered "harmful" may vary depending on the service. For example, public safety communications give rise to very different interference scenarios and concerns as compared to commercial activities. Because of the different policy concerns and definitions of "harmful" interference, the Subcommittee makes no judgment as to the appropriate legal definition. However, we note that ambiguities as to what constitutes "harmful interference" and delays in adjudicating harmful interference issues for proposed new spectrum users may in some circumstances serve to delay innovative services unnecessarily and may deter capital formation for technical innovations.

Accordingly, we use the term "interference" in its generic sense. The level or amount of interference that may be acceptable from a legal standpoint after balancing the competing public interest benefits is not addressed in this report. For example, when we discuss that communications investment requires certainty that the equipment will not be subject to unanticipated interference, we assume that the NTIA or the FCC would be employing the applicable definition of interference that is appropriate to that service. Those decisions are best

left to the types of services that may be involved in specific sharing proposals. We note that while it might be impossible to make an unambiguous definition of “harmful interference,” national clarifications in this area along with a more transparent and speedy system for making specific determinations will likely have a positive impact on wireless innovation.

We recognize that investment in communications technologies requires “certainty” that the investment will be realized. In this regard, investors in communications systems should have an expectation that their communications services will be free from harmful interference. Nonetheless, the explosion in new spectrum-based services requires that all spectrum users employ spectrum efficient technologies. In this regard, spectrum managers must find a proper balance which will continue to stimulate investment in communications systems and also provide spectrum access for new technologies and services. In many instances, we believe the rapid pace of technological change may allow for increased spectrum sharing opportunities without causing harmful interference to incumbent systems and investment.

The following recommendations are intended to outline some of the the “tools” that may be employed by spectrum managers to reduce interference and thereby facilitate the more efficient use of spectrum. While the use of “guardbands” is listed first, this should not be construed to mean that it is the preferred mechanism to prevent interference. It merely reflects that this tool has been used historically as a means to avoid interference. The development of new dynamic spectrum access techniques, including the use of geolocation/database approaches and spectrum sensing technologies, will provide new opportunities for more efficient use of spectrum. Indeed, the subcommittee believes the government should be encouraged to develop these new dynamic spectrum access techniques and where appropriate, employ them to encourage a more efficient use of spectrum.

1. Guardband Recommendations

The NTIA, FCC and other Federal agencies responsible for spectrum management have effectively employed guardbands to avoid interference. Where appropriate, guardbands should continue to be used as a tool to reduce the effects of out-of-band emissions (OOBE) and adjacent channel interference. They are not necessarily useful in reducing the effects of intermodulation or interference for small, low cost devices and have only a modest impact in reducing the effects of receiver-generated intermodulation.

To provide greater certainty with respect to spectrum use rights, and thereby stimulate investment in incumbent communications services, NTIA or any government entity employing guardbands in spectrum policy should be guided by the following principles:

- For new services, the spectrum used for such a guardband should come from a new service commencing operations and not an incumbent service, if that would be in the public interest.
- If an incumbent service makes changes to its system's architecture or modulation technique that result in new interference, then the spectrum to be used to establish any guardband protections should be provided by the service making such changes, if that would be in the public interest.
- When allocating spectrum for new services, guardbands should not simply reflect current OOBE rules. A realistic assessment of the potential for OOBE interference should be analyzed to ensure the size of the guardband is appropriate. This assessment should consider filter performance that is commercially available and performance that can be reasonably expected in the near term.
- Where appropriate, "virtual guardbands" using dynamic spectrum access techniques may be considered as an alternative to physical guardbands on a case-by-case basis.
- Consistent with the recommendations contained herein, when employing physical guardband techniques, government policy makers may consider whether the equipment to be protected from harmful interference is dated technology that can reasonably be upgraded to mitigate adjacent band interference.

2. Frequency Coordination Recommendations

Frequency coordination has successfully been used by the NTIA, the FCC, other government agencies and private entities to mitigate interference. These efforts have been especially useful in coordinating homogeneous services. However, future coordination is likely to involve more disparate, heterogeneous services, thereby complicating these efforts. In addition to the techniques previously employed, we suggest that the NTIA, the FCC and other government agencies responsible for spectrum management should:

- Move forward with a complete spectrum inventory to assist all future spectrum coordination efforts.
- Recognize that frequency coordination becomes more complex when sharing spectrum with unlicensed devices or devices approved as part of a “blanket licensing” regime, and coordination may be impossible if such devices are “untethered” or not connected to an accurate spectrum database or other management control system.
- Understand that the NTIA, the FCC and other government entities managing spectrum may have to play a greater role in frequency coordination, especially where commercial and government entities will share spectrum and also where different commercial services are sharing spectrum.
- Utilize private market mechanisms, such as negotiated interference solutions, to facilitate frequency coordination.

3. Dynamic Spectrum Access Recommendations

Recent developments in dynamic spectrum access (DSA) may offer new opportunities to increase spectrum sharing options, but may have certain limitations depending on potential interference scenarios that are associated with different radio services.

Sound spectrum policy requires a realistic assessment of the interference avoidance mechanisms of DSA techniques, through additional testing and evaluation, including NTIA’s ongoing Test-Bed initiative.

Cognitive Radio and Spectrum Sensing Technology

Cognitive radio and spectrum sensing technologies may become an important tool in spectrum sharing policies in the future. NTIA, the FCC and other government entities responsible for spectrum management should:

- **Establish procedures that examine the efficacy of spectrum sensing devices to protect services that employ different system architectures and modulation systems.**
- **Ensure that such technologies, like any new or existing radiofrequency (RF) device, comply with existing transmitter and/or receiver regulations applicable to the various services that may occupy those frequencies. Nonetheless, the adaptive capabilities of these technologies may create challenges to mitigating interference and will need to be examined as they become available.**
- **Examine the application of this technology as a sharing and interference avoidance tool on a case-by-case basis for each radio service as DSA technology becomes available, because cognitive radio and spectrum sensing technologies may create unique interference challenges to different system architectures. Examples include certain safety-of-life bands (e.g., GPS and public safety) and services (e.g., passive radio astronomy and broadcasting).**
- **While additional research is always important, government efforts should focus on testing and evaluation to ensure that such technology will develop properly and not lead to interference. Further field and laboratory testing is necessary in the following areas:**
 - **The efficacy of spectrum sensing devices to protect other fixed, mobile and portable devices from all types of interference.**
 - **The potential for interference due to a DSA device’s potential inability to sense an occupied channel due to a “hidden node.”**
 - **The ability of the DSA device to sense signals at low enough levels to protect other spectrum users without producing substantial “false alarms” to render the devices useless.**
 - **The ability of the entire DSA system to effectively prevent interference. For example, the effect of antennas on the ability of a device to adequately receive/sense a signal from an existing spectrum user should be examined.**
 - **Examinations should include how an actual DSA device will operate in its environment as part of the communications ecosystem.**
- **The NTIA, the FCC and any other government entities responsible for spectrum management should increase significantly the resources directed to provide further testing, evaluation and development consistent with the above recommendations. Several sources of funding should be explored including an increase in Congressional appropriations, auction revenues or appropriate spectrum fees that are consistent with the cost of regulation.**
- **The NTIA and the FCC should also explore cooperative real time spectrum sharing arrangements in which the primary user actively signals the sharing party about both real time spectrum availability and near term projections.**

Database and Geolocation Approaches

In general, the creation of a spectrum database is essential to provide spectrum managers with information necessary for future spectrum planning. Consistent with the goal of spectrum inventory legislation, the NTIA, the FCC and other government spectrum managers should examine actual usage of spectrum assigned to government and commercial entities. We support current legislative and government efforts to inventory spectrum use by commercial and government entities.

In its most comprehensive form, a database – when combined with a geolocation system – may provide a mechanism to facilitate spectrum sharing. As part of the government’s efforts to conduct an overall spectrum inventory, government entities managing spectrum should complete a comprehensive spectrum inventory for the frequencies on which sharing is proposed, to ensure that a database system effectively mitigates interference.

- When developing a comprehensive database to facilitate spectrum sharing, the NTIA, the FCC, government agencies and other entities managing spectrum on behalf of the government should:
 - Construct the database so it can provide accurate information regarding spectrum use in real time, where feasible. In creating this database, government spectrum managers must develop specific metrics, which define spectrum use. Such an examination should involve determining what constitutes a usable signal. For example, this could be arrived at by specific signal measurements or use of predictive models that define protected service areas. Use may also be defined not only in terms of geographic areas, but also in terms of time and duration.
 - Maintain administrative control over the database or distribution of the database where government spectrum is involved or in cases where government spectrum will be shared.
 - To the extent a government agency delegates the creation and maintenance of a database to any private entity, the government should enact policies to maintain direct oversight over all aspects of the database management including, information distribution to database administrators, spectrum managers and devices relying on database information.
 - Where appropriate, database information should be made available to the public to provide transparency and proper oversight. Such access must be consistent with concerns regarding national security. From an operational standpoint, however, government spectrum managers may find it appropriate to limit real time access to database information to those devices that have been certified or approved to use the database by the NTIA, the FCC or an appropriate government entity. In the interest of transparency, provisions may be made to allow for non-real time access by other parties interested in improving spectrum utilization. If the data contains sensitive details about national security, the non-real time access might contain aggregated data that protects sensitive details.

- All DSA devices relying on or using the database must receive an appropriate authorization code to the database or database administrator before transmitting on any frequency. Where feasible, such authorization shall be updated continuously. Should a device fail to receive an authorization code or signal, it will cease operation on the frequencies assigned by the database.
- Adopt specific end-to-end security to ensure that only authorized DSA devices are able to access database information and prevent the database from being “hacked.”
- Ensure the technical security of the database and all devices using the database. A database approach may not be appropriate for sharing spectrum with DSA devices that are classified.
- DSA devices relying on a database to avoid interference should be capable of being turned off remotely in a timely manner, if they are causing interference. Interfering devices shall cease operation on those frequencies causing interference while resolving bona fide interference complaints. Complaints should be resolved within 30 days.
- Provide for equal participation by incumbent users and new users in the establishment and maintenance of any databases and where appropriate, participation by third parties.
- Place primary emphasis on protecting existing services from additional harmful interference.
- Consider the types of DSA system architectures and devices that will rely on the database. While in some cases a database can be used for both fixed and mobile devices, there may be scenarios (or bands) where a database is not appropriate for mobile and portable systems.
- Sound spectrum policy may benefit from the use of both cognitive radio and database systems. In addition, data gleaned from cognitive radio/sensing technology may become an important component in ensuring the accuracy of a database system.

Resources should be devoted to additional research regarding the use of databases to provide additional sharing opportunities. For example, future database approaches may include not only geographic coverage information, but other factors such as the time of day spectrum is being used.

4. Harmonized Spectrum to Facilitate Grouping Services Recommendations

In the search to find additional spectrum and optimize spectrum allocations, policymakers must remain vigilant in realizing the benefits of promoting regional and/or globally harmonized spectrum allocations wherever possible. These benefits include:

- Significant economies of scale in the development and deployment of both infrastructure and devices;

- **Major enhancements to roaming across international borders;**
- **Enhanced interoperability among various services, devices and platforms.**

While recognizing these benefits, policy makers should also consider the potential impact of such harmonization on the development of new, innovative uses of spectrum and wireless technologies.

5. Allocation Decisions: Sharing Like Services/Mixing Disparate Services

Policymakers must also strive to cluster like services when allocating spectrum wherever possible. Such clustering of like services is important because:

- **Clustering of like services is frequently a beneficial by-product of harmonized spectrum allocations.**
- **There is widespread consensus on the mechanisms and dangers of creating interference when licensing services that employ different duplexing technologies in adjacent spectrum. Careful attention is needed in such “boundary conditions” to avoid harmful interference.**

Some have noted that an example of the problems associated with mixing disparate services is illustrated in the plans to permit TDD operations in AWS-3 spectrum, without adequate allowances to protect adjacent AWS-1 FDD operations.

6. Equipment Standards Recommendations

The NTIA, the FCC, and other government spectrum managers should devote substantial resources to establish a wide-ranging evaluation process for new devices that use spectrum to transmit or receive signals. Increased demand for spectrum and the possibility of expanded sharing opportunities requires policymakers to focus on the importance of future receivers and transmitters as tools in achieving greater spectrum efficiency.

Historically, equipment standards have necessarily involved trade-offs between improved spectrum efficiency and consumer costs. Recent developments seem to indicate that new approaches may allow for the low cost production of receivers that are more spectrally efficient. A more detailed analysis of these technologies is needed. Accordingly, the following constitutes preliminary observations regarding an approach to equipment standards.

Government spectrum managers should consider incentives, rules and policies to:

- **Improve the capability of receiving devices to reject adjacent channel interference.**
- **Improve devices to reduce the out-of-band emissions (OOBE) and adjacent channel interference from transmitting devices. Review existing OOBE regulations, including the 43+ 10logP attenuation requirement as well as the Part 15 Section 209 Emission Limits, to ensure they provide sufficient protection when applied to new and varied services.**
- **Improve and reduce unintentional emissions from all electronic devices.**

Investment in commercial and government communications services requires certainty that the equipment provided will not be subject to interference from new services sharing spectrum. Future spectrum planning must give consideration to the investment in existing legacy devices. Investment in equipment should not be stranded unnecessarily due to new services or devices that cause interference.

New services acquiring or accessing spectrum should be made aware of the interference characteristics of receiving and transmitting equipment operating on frequencies that will be shared or used in adjacent bands. The NTIA, the FCC or government entities responsible for managing spectrum should establish a clearinghouse to make such information available to those seeking to obtain spectrum access. Such information will give new services necessary visibility about the potential for interference for such equipment, before the new services access or bid for spectrum.

We recommend that the government fund research to accelerate development of monolithic radiofrequency (RF) filters (e.g., FBAR, MEMS) to improve selectivity, linearity and dynamic range of portable transceivers (e.g., LMR portables and cellular phones) without affecting size or power consumption. The ability to tune high-selectivity filters and produce components in low volumes cost effectively should also be an objective of the funding. Thus a better dialog between the filter community and spectrum managers is essential as filter performance has a large impact on spectrum efficiency.

The NTIA, through the Institute for Telecommunication Sciences Laboratory (ITS), should characterize the unwanted emission levels of commercially available wireless devices and compare them to existing FCC standards to facilitate sharing with government users and to determine if changes should be made to the standards.

Technical improvements to transmitting and receiving equipment will permit greater spectrum sharing over time, as new generations of equipment come on line. When developing future spectrum sharing policies, spectrum managers should take into account changes and improvements in legacy equipment that will occur in the marketplace. While recognizing potential improvements in transmitting and receiving equipment, NTIA government spectrum managers should also consider the replacement rate of existing transmitting and receiving equipment, to avoid the potential for

unnecessary stranded investment in this equipment. In doing so it should try to balance the cost of stranded investment with the public benefits of more spectrum access to both federal government and other users.

7. Enforcement Recommendations

The NTIA, the FCC and government entities with spectrum management responsibilities need to shift from interference prevention only approach to both prevention and rapid resolution of problems that occur. Enforcement will become an important aspect of making more spectrum available to meet growing demands and introduce new spectrum-dependant applications as sharing opportunities increase. But new spectrum applications may also uncover limitations on existing regulations that were unanticipated. Both need timely resolution to limit the resulting harmful interference. These spectrum managers should:

- Put in place streamlined interference reporting tools to complement “spot monitoring” of new operations.
- Increase penalties for violations. There should be a tiered series of penalties for violations of existing spectrum management rules that cause interference, with increased penalties, especially for incidents that put safety-of-life systems at risk.
- Increase budgetary resources for monitoring and enforcement. Budgetary funding should be increased to facilitate increased laboratory testing and field monitoring by the FCC and NTIA after new rules are implemented for advanced wireless technologies. Several sources of funding should be explored including an increase in Congressional appropriations, auction revenues or appropriate spectrum fees that are consistent with the cost of regulation.
- Per the FCC’s FY11 budget proposal language to resolve “100% of non-emergency interference complaints” in one month, the NTIA should encourage the Commission to expand this to a broader “shot clock” approach to responding to interference complaints so that licensees and operators of unlicensed devices will have certainty as to the timetable for concerns to be addressed.
- Develop tools for Temporary Restraint of Interference (TRI). Government entities responsible for spectrum management should establish a process, similar to a temporary restraining order, to address egregious interference complaints immediately. Upon a bona fide showing of interference from a specific device, class of devices or service, an entity receiving such interference should be able to file a complaint with the appropriate government agency. Upon an appropriate showing, the device or entity causing the interference shall cease such harmful transmissions, while the case is being examined by the appropriate government agency. This recommendation is not intended to alter

the various spectrum priorities of existing law. For example, a device or service that is secondary in a band would lack standing to restrain an interfering device that has been given primary status.

- **Develop and explore the use of remote shut-off technologies for resolving interference problems. In cases where interference occurs, government spectrum managers, or government authorized frequency coordinators, should, upon a proper showing, and good faith attempt to notify, have the ability to remotely turn off transmitting equipment that is causing actual interference to other services.**
- **Increase assessments/Test-Bed approach. The ability of cognitive radio (software defined radio) technology to sense the surrounding RF spectrum environment can be harnessed to assist in reporting cases of “bad actors” in which nearby RF emitters are operating outside of their permissible parameters and causing interference.**
- **Equipment authorization will be an important tool in facilitating spectrally efficient equipment. It may be appropriate for the FCC and NTIA to review equipment authorization practices, such as spot checking, to ensure there are adequate and correct incentives to manufacture and distribute spectrally efficient equipment consistent with the FCC and NTIA rules.**
- **Establish a streamlined process for the maintenance and retention of interference reporting and enforcement data. Such data should include documentation of interference that may be caused by legally authorized operations. Analyzing these data will provide an ongoing assessment of FCC and NTIA spectrum management and enforcement policies.**
- **Explore through legislation, regulations or industry/government agreements, the ability of the federal government to expand its enforcement of spectrum interference rules, especially as it may relate to public safety and law enforcement.**

INTERFERENCE SUBCOMMITTEE WORKING GROUP: DRAFT INTERIM/FINAL REPORT

I. INTRODUCTION

For the benefits of new and existing wireless services to be fully realized by consumers, the government must provide a clearly articulated set of rules and policies that defines the interference rights of entities using spectrum. As a general matter, the NTIA, the FCC and other spectrum managing agencies have sought to avoid “harmful” interference. Different terms such as “disruptive interference” or “destructive interference” are sometimes employed. As a legal construct, they all involve the balancing of interests, where the potential service loss is balanced against the benefits of providing new service. Often this analysis involves an assessment of predictive models based on probabilistic reception and interference analysis. Moreover, the amount of interference that may be tolerated before it is considered “harmful” may vary depending on the service. For example, public safety communications give rise to very different interference scenarios and concerns as compared to commercial activities.

The phrase “harmful interference,” however, is a legal concept used repeatedly in the Communications Act of 1934, as amended¹. At present the FCC, NTIA, and ITU use the same definition, one apparently developed before most of today’s wireless technology was developed. Obviously, the introduction of any new service will increase interference to some degree. Policies that flatly prohibit any increased interference may have the unintended consequences of precluding new services. Moreover, the advances in DSA techniques may reduce this risk as technology improves. On the other hand, investment in communications services should encompass an understanding that equipment should not be stranded due to new, unanticipated harmful interference. These policy balances will vary considerably based on the types of services that are being shared. Because of the different policy concerns, the Subcommittee makes no judgment as to the appropriate definition of interference that would trigger legal action.

We note that the Federal Communications Commission is addressing the issue of interference in the context of fostering innovation in the wireless market.² In that proceeding the Commission has observed:

Spectrum allocations and access often hinge on controlling interference between new services and incumbent services, as do licensing and service rules to some extent.

¹ 47 USC 302a, 303(y), 337, 354, 922, 923, 1100

² Fostering Innovation and Investment in the Wireless Broadband Market, Gen Docket No. 09-157, FCC 09-66, released August 27, 2009.

The resolution of disputes about potential or actual interference in rulemakings can pose a major impediment to the introduction of new services, devices and technologies, either as a result of long delays in the establishment of service rules or the imposition of onerous and perhaps unachievable technical standards. . . . The viability of spectrum access for new radio services often centers on whether the new service may cause harmful interference to incumbent services. This can lead to delays through protracted rule making proceedings that can create uncertainty and discourage investment³

Thus, it is important for the NTIA and FCC to work together to try to clarify what constitutes “harmful interference” even if an unambiguous definition is impossible and to try to speed up the resolution of such questions so that investment in innovative wireless technologies is not unnecessarily discouraged.

In the context of this report we use the term “interference” in its generic sense. The level or amount of interference that may be acceptable from a legal standpoint after balancing the competing public interest benefits is not addressed in this report.⁴ Those decisions are best addressed in the context of specific services that may be involved in specific sharing proposals.

Neither the public interest nor consumer welfare is maximized where the allocation of new services leads to a level of interference where existing equipment or new services are unable to operate. For example, a new service that could provide billions of dollars in economic activity may never realize its potential if the equipment is subject to interference, which prevents the service from operating. The same is true for incumbent services. Moreover, providing certainty from such harmful interference is essential to the development of technology, provision of quality of service and stimulation of investment in communications services. Certainty from such interference is also important for proper planning by the users of government spectrum. The key is to balance and optimize the services, both old and new, that will be made available to the public, and to resolve questions on specific examples in a timely manner. These issues become quite complex as different service architectures either share spectrum or operate on adjacent frequencies. Interference problems become more challenging as new services and generations of equipment, some not anticipated when the initial sharing rules were implemented, commence operating in a particular band. Moreover, present enforcement rules and policies appear to be insufficient to prevent interference or have the interfering entity internalize the costs of causing interference to victim receivers.

The objective of the Interference Subcommittee’s report is to provide a comprehensive approach to analyzing the various types of interference, and to recommend approaches to resolving interference problems that are likely to be encountered.

³ *Id.* at paras 34-35.

⁴ For example, when we discuss that communications investment requires certainty that the equipment will not be subject to unanticipated interference, we assume that NTIA or the FCC would be employing the applicable definition of interference that is appropriate to that service.

II. SCOPE OF ISSUES EXAMINED

Interference issues involve highly complex and technical considerations for radiofrequency spectrum use. The mechanisms that cause interference and the solutions to resolve interference will vary depending on technology, spectrum, terrain and usage. In addressing this issue, we first identify the various mechanisms that cause interference. We shall discuss issues pertaining to co-channel interference and other sources of interference such as, adjacent channel and out-of-band interference.

Second, we examine a variety of methods that may be employed to prevent or control interference including: 1) the use of guardbands, 2) frequency coordination, 3) DSA, including cognitive radio and database systems, and 4) harmonization of spectrum allocations.

Third, we discuss the relationship between spectrum efficiency and receiver performance. As policies are developed to increase spectrum sharing, greater emphasis needs to be placed on receivers and transmitting devices. This is especially true in the context of unlicensed operations, in which interference avoidance rests exclusively on the functionality of the equipment as opposed to a specific licensee.

Fourth, we believe government agencies responsible for spectrum management must enact interference avoidance rules and policies that can be enforced. In the case of the NTIA and the Department of Commerce, additional authority may be required to enforce interference policies among Federal agencies. Moreover, enforcement coordination between the NTIA and the FCC will be required if additional commercial/government sharing polices are enacted. Sound spectrum management dictates that government agencies responsible for spectrum management provide mechanisms for the quick resolution of interference issues and spectrum disputes.

Finally, with increased demand for spectrum, interference standards and rules will have a direct impact on both investment certainty of incumbents and the ability of technical innovators to pursue promising technologies in the public interest. It is important that interference parameters and expectations be established before spectrum is acquired, accessed or in the case of unlicensed devices, before it is authorized for use. To the extent possible, the government should seek to establish a basic set of principles to guide policy makers in enacting consistent interference policies across all services. These standards should address the issue of when worst case “minimum coupling loss” should be used for harmful interference determinations and when it is appropriate to use probabilistic models. Improving the speed and transparency of harmful interference determinations will encourage investments in both incumbent systems and in innovative technology.⁵

⁵ Future reports should explore the use of probabilistic models in greater detail. In this regard we note the increased use of probabilistic models in CEPT and ITU-R. *See* Statement of M2Z Networks, Inc, Regarding CSMAC Interference and Dynamic Spectrum Access Subcommittee Interim Report, July 27, 2010 at 2.

III. THE DELIBERATIVE PROCESS

Members of the subcommittee are spectrum policy experts from a wide variety of professional backgrounds. Most have served in government, having responsibility for a broad array of spectrum-related issues. All members have had direct experience with numerous interference-related issues from both a technical and policy perspective.

Beginning last fall, the subcommittee conducted weekly conference calls. Each subcommittee member was asked to submit a draft on one or more of the specific topics mentioned in Section II. Draft documents were circulated among the subcommittee members for their review. Each member was invited to submit comments on the various submissions. In addition, we conducted face-to-face meetings to further coordinate our edits and recommendations.

To assist us in document review, the subcommittee created a document repository using Box.net. This repository included both draft documents as well as archived reference materials.

IV. WORKING GROUP ISSUES AND RECOMMENDATIONS

The following outlines our specific recommendations. We first discuss the various sources of possible interference. We then address suggested techniques and tools to remedy various types of interference that may be encountered. As noted below, there are several types of interference. This section will describe briefly these interference mechanisms.

Sources of Interference

- **Co-channel: Interferer and Victim Use the Same Frequencies**
- **Inter-channel Interference: Interferer and Victim Use Different Frequencies**
 - **Out-of-band emissions**
 - **Adjacent channel interference & receiver selectivity**
 - **Spurious responses**
 - **Intermodulation**
 - **Receiver blocking and overload**
- **Likely Interference Scenarios**
 - **Transmit/receive**
 - **Near/far issues**
- **Overall Affects of Interference**

A. SOURCES OF INTERFERENCE

1. CO-CHANNEL INTERFERENCE

Co-channel interference occurs when two or more entities in the same geographic area transmit on the same frequency. Co-channel interference reduces signal-to-noise ratio (SNR), which, in turn, reduces throughput and can even interrupt communications when the SNR drops below the level necessary for a particular technology to operate effectively. Co-channel interference is problematic for many services. Unlike other forms of interference, such as adjacent channel interference, the problem cannot be corrected by filters or by improving the interference rejection capability of the receiver, which blocks out-of-band emissions or transmissions on adjacent channels. Moreover, because the interference occurs on the precise channel that a consumer is using, improvements in receiver sensitivity and reception may have the unintended consequence of making services more susceptible to co-channel interference. In addition, co-channel interference may occur over broader geographic areas than other types of interference.⁶ As a result, regulators have often employed greater distance separations between co-channel emitters and the use of directionalized antennas.

Co-channel interference occurs in broadcast, cellular telephone, and WiFi, WiMax and Land Mobile Radio (LMR) systems, among others. In a cellular system, for example, spectrum is reused at close spacing, causing systems to be interference-limited, meaning that interference power, rather than thermal noise power, limits the coverage range of sites. Most modern cellular technologies, such as CDMA2000, W-CDMA and LTE are single-frequency systems, meaning all cells at all sites use the same spectrum and thus experience high co-channel interference.⁷ LMR systems are generally operated as noise-limited systems but co-channel interference exists in these systems as well and is generally mitigated by coordinating where a frequency may be used such that co-channel interference is reduced to an acceptable level. In the broadcasting context, co-channel interference is avoided by employing geographic separations between co-channel transmitters or the use of highly directionalized transmitting antennas.

Figure 1 shows the co-channel interference paths in cellular single frequency reuse (a) and LMR (b) systems. Black arrows indicate the desired signal and red arrows indicate co-channel interference signals.

⁶ Co channel interference may also occur as a form of spurious emissions. See discussion at. Sec. 2.3.

⁷ Acceptable service is achieved by ensuring that a high SNR is maintained for the closest base stations.

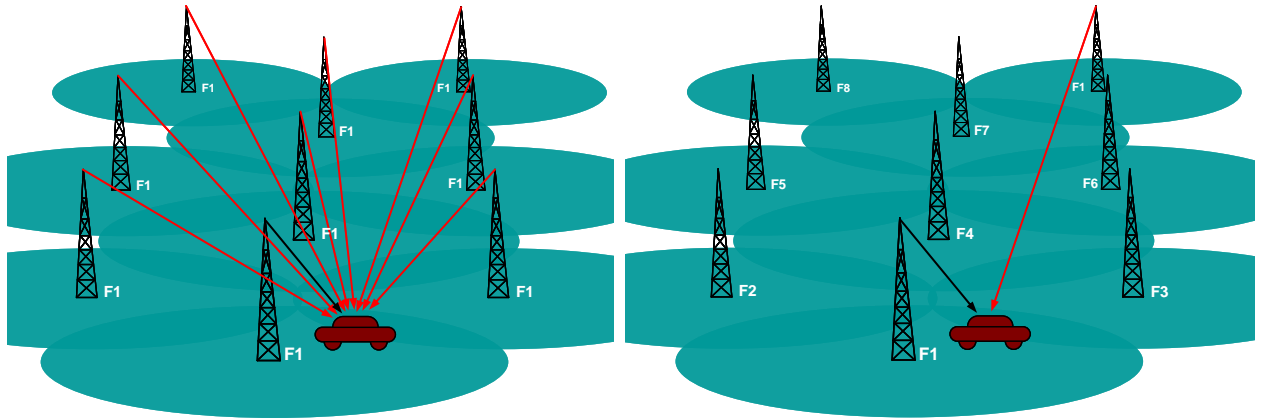

Figure 1 – Co-Channel Interference Paths

2. INTER-CHANNEL INTERFERENCE

The term inter-channel interference reflects a series of potential interference issues that may occur throughout a communications system’s service area. In many respects, inter-channel interference may be more difficult to address than co-channel interference. First, the interference may occur throughout a system’s service area. Second, because system architectures may be different, the potential for interference may increase. Different services using adjacent bands or adjacent channels may employ vastly different techniques for resolving these issues. However, such solutions may not be equally applicable to all architectures. Moreover, inter-channel interference is a function of the performance of both transmitters and receivers; interference can result from insufficient transmitter performance, receiver performance or a combination of both.⁸ In general, inter-channel interference is thus related to the performance of filters in both transmitters and in receivers. Practical filters can not be made to have square corners and perfectly separate bands, however, filter performance is constantly improving with time in an analogous way to microprocessor performance described by Moore’s Law. Thus one of the challenges of spectrum policy is to decide what level of transmitter and receiver performance is appropriate at a given time.

2.1 OUT-OF-BAND EMISSIONS

Transmitter emissions that fall outside of the transmitter’s intended channel bandwidth are known as out-of-band emissions (OOBE) or, equivalently, as sideband noise. This noise splatters into the adjacent channels and into other bands, generally getting smaller and smaller in strength as the frequency offset from the transmitter frequency increases. Figure 2 shows the source of OOBE and its effect on inter-channel receivers.

⁸ Silicon FlatIrons, *Radio Regulation Summit: Defining Inter-channel Operating Rules*, December 2009 at 7.

OBE enters receivers on other channels and sums with the thermal noise floor of the receiver. The increase in noise power in the receiver requires an equal increase in desired signal power to maintain equivalent SNR and thus causes a reduction in the sensitivity of the receiver. Because the interference is due to noise that is on-channel to the receiver, there is nothing that can be done at the receiver to mitigate interference due to OBE.

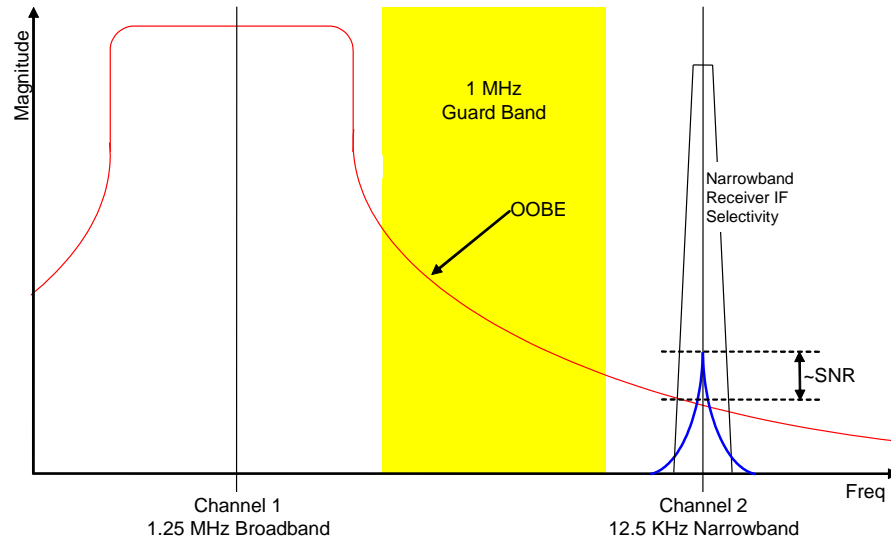

Figure 2 – Source of interference due to OBE

As demand for spectrum increases and additional devices begin to share spectrum, spectrum managers may be required to revisit OBE rules. In some cases, this will be required because the use case of some devices has changed dramatically. Another issue involves the sheer number of devices that transmit in the band. Thus, as spectrum sharing becomes more commonplace, NTIA and the FCC should frequently reevaluate their out-of-band emission requirements.⁹

2.2 ADJACENT CHANNEL INTERFERENCE & RECEIVER SELECTIVITY

Desensitization is the measure of a receiver’s ability to reject off-channel signals. Desensitization of a desired signal at reference sensitivity level due to an adjacent channel

⁹ This problem can be seen in the post-transition reception tests of DTV stations. The growth in the number of in-home electronic devices has effectively increased both unintentional radiators as well as out-of-band emissions from transmitting devices. For example, the §15.209 emission limit in the UHF TV band is 200 microvolts/meter at a distance of 3 meters. The 200 microvolts/meter is the same as 46 dBu. Accordingly, the out-of-band energy permitted under §15.209 is actually 5 dB higher than the value of 41 dBu used to define a TV station’s protected contour. Since these unwanted or out-of-band emissions can be on a channel that is being used for TV operations, rather than being 5 dB higher such emissions have to be 23 dB lower to avoid interference and meet the co-channel D/U ratio of +23 dB. This analysis shows that, in this context, the FCC’s OBE protections in §15.209 may be inadequate and should be reevaluated.

signal is called specifically Adjacent Channel Rejection (ACR) in the Telecommunications Industry Association (TIA) specifications¹⁰ TIA-603 and TIA-102CAAA. The procedure detailed in the TIA documents for measuring ACR can be used to quantify receiver desensitization at any frequency offset and for higher desired signal levels, which is commonly called receiver blocking.¹¹

There are several factors that may contribute to a receiver's desensitization characteristic. The receiver IF selectivity may be inadequate to reject strong signals, typically in the context of land mobile operations, in excess of -50 dBm, on adjacent channels. This has been a major factor in determining the receiver's ability to reject strong signals on adjacent channels, but with the availability of inexpensive ceramic filters and digital signal processing, it is less so with modern equipment.

Receiver local oscillator noise can fold into the IF pass band by mixing with a single high level signal, typically in excess of -50 dBm, and usually within 500 kHz of the desired signal. This mechanism is often confused with adjacent channel interference, which results from the adjacent channel interferer's modulation products falling in the receiver's IF pass band. Local oscillator sideband noise is a contributing factor to a receiver's ability to reject strong signals at offsets greater than the adjacent channel.

An additional consideration is the spectrum of the interfering signal vs. frequency offset. If the interfering signal has a broad spectral footprint or a high noise floor, the receiver desensitization measurement will indicate poor desensitization performance even for very well designed receivers.

Figure 3 shows sensitivity level desensitization performance for two typical land-mobile radio products, one considered having high-tier performance and the other considered having low-tier performance. The figure includes the desensitization levels due to two types of off-channel signal sources. One of the sources is a high performance signal generator, modulating a 400 Hz tone at 3 kHz deviation. The other source is a base station transmitting a narrowband linear modulation and meeting all FCC specifications.

¹⁰ TIA-603 and TIA-102CAAA are specifications intended for land-mobile radio products and may not be applicable to other services. A survey of specifications applicable to other services is presented in NTIA Report 02-404.

¹¹ This issue applies to other services as well. For example, adjacent channel interference is also an issue in the broadcast band. Because television sets receive signals over a broad range of frequencies, adjacent issues and the resulting desensitization are significant concerns for consumers, TV receiver manufacturers and broadcasters. To avoid such interference, the government has used specific separations rules for broadcast stations and land mobile operations that operate on adjacent frequencies. Adjacent channel interference issues will arise as policies promoting sharing expand.

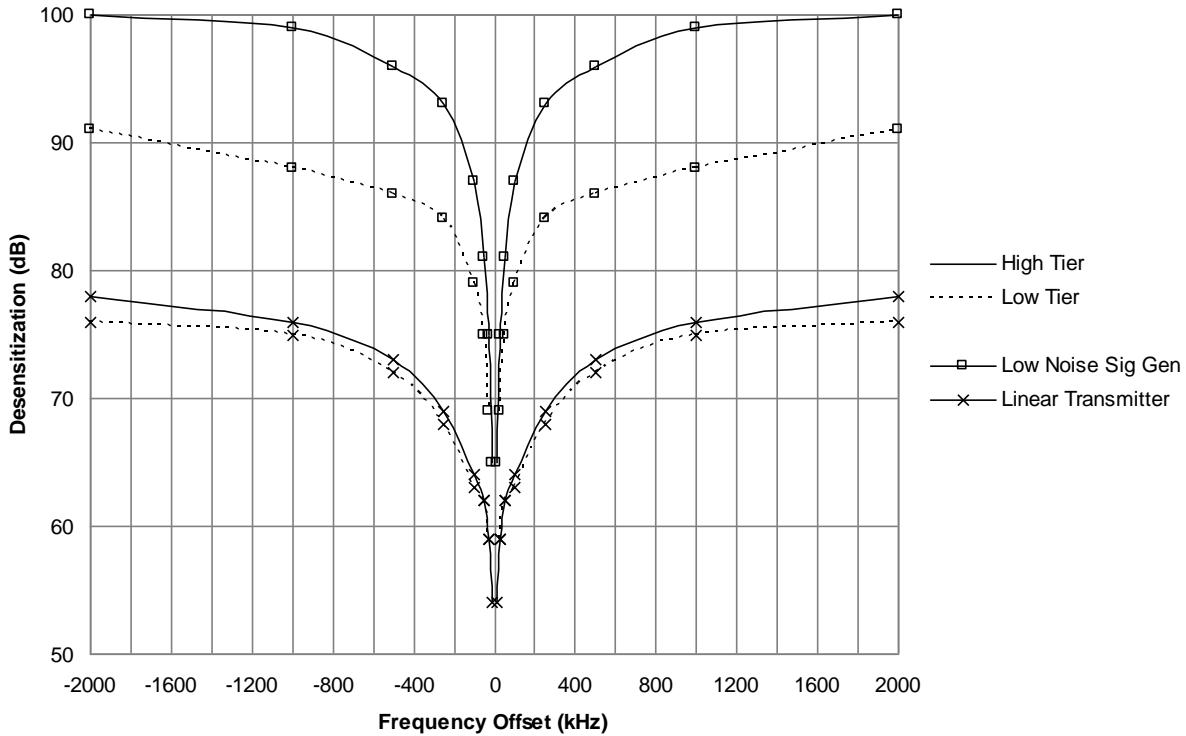

Figure 3 – Desensitization curves for typical land-mobile radio receivers

Figure 3 shows that when a high performance signal generator is used as the interference source, high-tier receivers will usually have ≥ 90 dB rejection of signals that are offset by ≥ 500 kHz from the desired channel and usually have better than 80 dB rejection for offsets greater than about 50 kHz. Low-tier receivers have about 10 dB lower performance. When a linear base station is used as the interfering signal source, the desensitization level of the high-tier receiver is approximately 20 dB less than when the high performance signal generator is used and the desensitization measured for the high and low tier receivers is about the same. The worse transmitter performance is due to the noise floor characteristic of the linear amplifier. This indicates that receivers employing improved designs will not necessarily have improved desensitization performance unless the noise performance of the transmitter is also improved.

2.3 SPURIOUS RESPONSES

It is common for transmitters to have elevated power levels at a small number of discrete frequencies other than the intended transmitter frequency. Likewise, receivers exhibit somewhat elevated sensitivity at a small number of discrete frequencies outside the intended receive frequency bandwidth. This effect is called spurious response. Spurious responses result from particular design choices such as synthesizer reference frequency and IF frequency. Spurious responses are only problematic when an undesired signal falls directly on a spurious response and with a signal strength approximately 80 dB or greater than the strength of the desired signal. Figure 4 shows the spurious response of two typical LMR receivers.

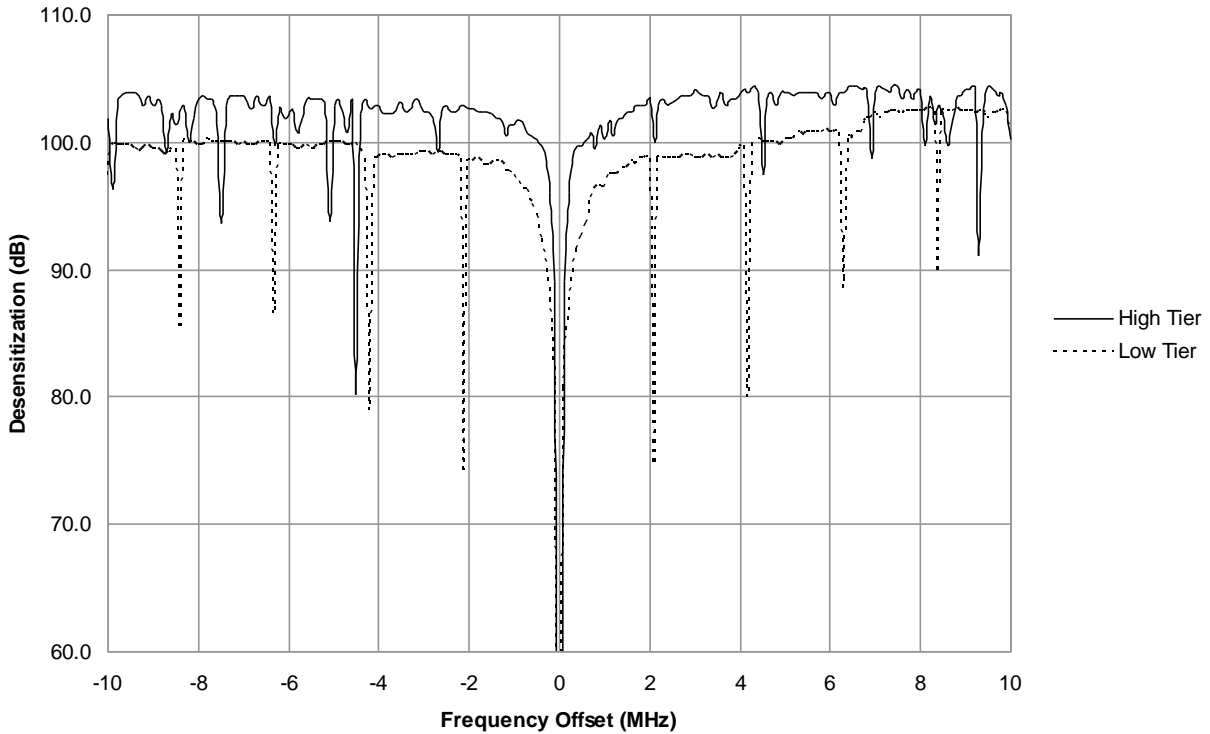

Figure 4 – Desensitization response of typical land mobile receiver showing spurious responses

2.4 INTERMODULATION

Receiver intermodulation (IM) is the result of mixing two or more over-the-air signals within a radio's receiver circuitry such that the mix products fall within the IF bandwidth of the receiver and add to its thermal noise floor, thus reducing the sensitivity of the receiver. IM is not due to the transmitter's spectrum output but to non-linearity within the receiver itself. This type of interference results when the undesired signal levels entering the receiver's circuitry are large, typically over -50 dBm, and then IM increases rapidly as the strength of the undesired signals increase.

Historically, IM was thought of as individual carriers at particular frequencies intermodulating such that the products would fall on particular, unfortunate frequencies. TIA defines an IM rejection specification, called IMR, using two discrete carriers, one at a frequency offset A from the receiver under test and the other at a frequency offset of $2A$. Doing this, a particular IM product, called a third-order product, will land on the test frequency. The amplitude of the IM product is a function of the carrier levels and the receiver's propensity to generate IM products. A low frequency, low deviation modulation is applied to the carrier at frequency $2A$. By modulating in this way, the intermodulation product that appears on the desired frequency is an exact copy of the low deviation modulation and, because of the narrowband nature of the modulation signal, will affect only the desired channel.

The above procedure for specifying and measuring IM is appealing for its simplicity and it was realistic for a period of time when all channels were narrowband. The signal levels that result in interference are obvious from the test procedure and transmitter sites could easily be evaluated for harmful IM products, which could then be eliminated by carefully choosing frequencies.

However, broadband signals change this considerably for a couple of reasons. First, it is impossible to avoid IM through judicious frequency selection because broadband signals can occupy much or all of a band. Further, the IM products produced by broadband signals are themselves broadband and can span the whole receive band. Given this, the traditional frequency management approaches to controlling IM no longer apply.

Figure 5 shows the effect of third-order intermodulation on a broadband signal. The red line in Figure 5 shows the signals as they enter a receiver. A narrowband signal, A at frequency F_A (8.67.5 MHz), and a 5 MHz broadband signal, B at frequency F_B (882.5 MHz), are shown. Intermodulation results in signals falling at frequencies $2F_A - F_B$ and $2F_B - F_A$. In addition, intermodulation results in broadband spectral components appearing around signals A and B themselves, which increases the probability that intermodulation products will land on the receiver's desired frequency and cause interference.

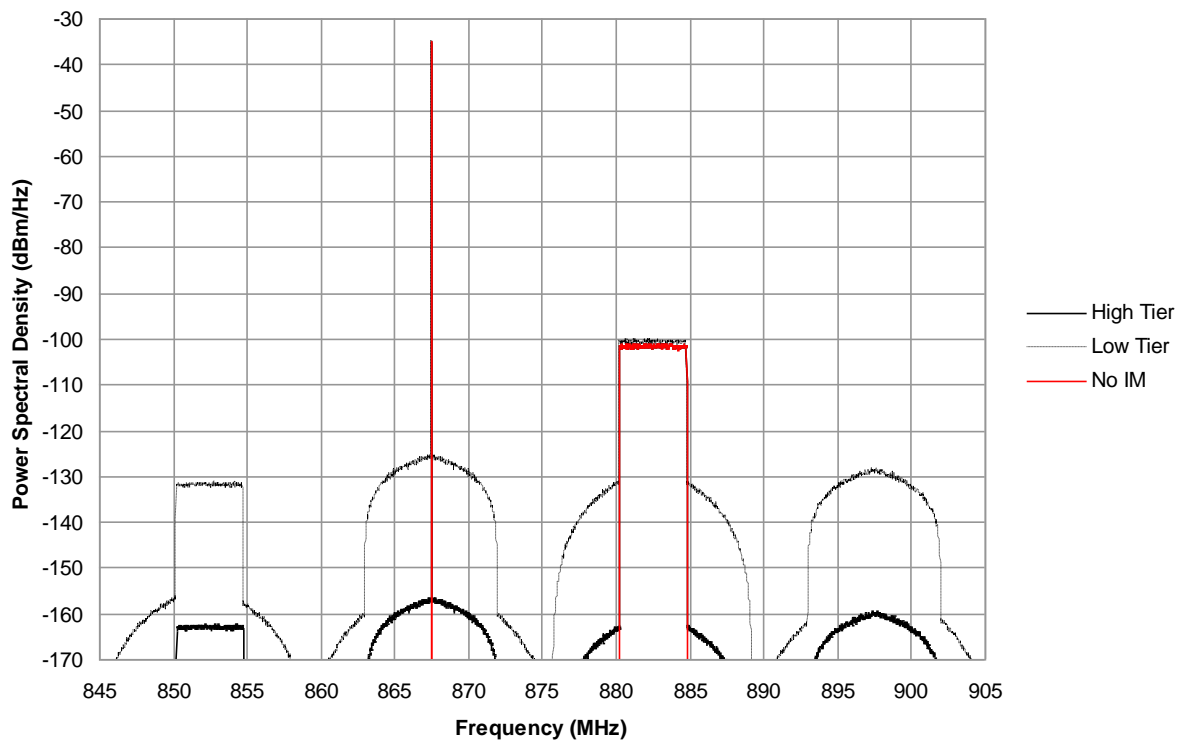

Figure 5 – Spectrum due to intermodulation of a broadband signal.

A property of intermodulation products is that their signal strength varies not in direct proportion to the input signals that cause them, but as a function of the signal strength and the order of the intermodulation product. For example, the third-order product generated in the TIA IMR test increases 3 dB for every 1 dB increase of the input signals. Higher order

products exist as well, and the strength of these products start smaller and increase faster than third-order products.

For the most part, interference due to IM, whether due to narrowband or broadband signals or a combination of the two, must be solved by improving the characteristics of the receiver itself.¹² Typically, improving the IM rejection of a receiver requires increasing the power consumed by the receiver in order to improve the linearity of low-noise amplifiers and the local oscillator power applied to the mixer.

2.5 RECEIVER BLOCKING (OVERLOAD)

The receiver front end can be overloaded by a single high level unwanted signal, residing outside of the desired channel, typically in excess of -25 dBm, or multiple high level unwanted signals whose total peak instantaneous power exceeds -25 dBm. This is known as receiver blocking. Receiver blocking due to high signal levels is not a significant cause of interference in most mobile systems because the limiting conditions tend to the OOB of transmitters and the selectivity and intermodulation performance of receivers.

3. INTERFERENCE SCENARIOS

Although there are many sources of interference, they generally only result in interference in certain scenarios. These scenarios are discussed in the two sections below.

3.1 TRANSMIT-RECEIVE SCENARIOS

Interference between base transmitters and base receivers or between mobile transmitters and mobile receivers is very common in unpaired spectrum. Unpaired spectrum use is prevalent in the Very High Frequency (VHF) LMR band and is making a resurgence with the introduction of the time division duplex (TDD) version of WiMAX and the forthcoming TD-LTE. Figure 6 shows the interference paths.

¹² Intermodulation interference may not be eliminated where spectrum is shared and the transmitter power of one service is much higher than the other service.

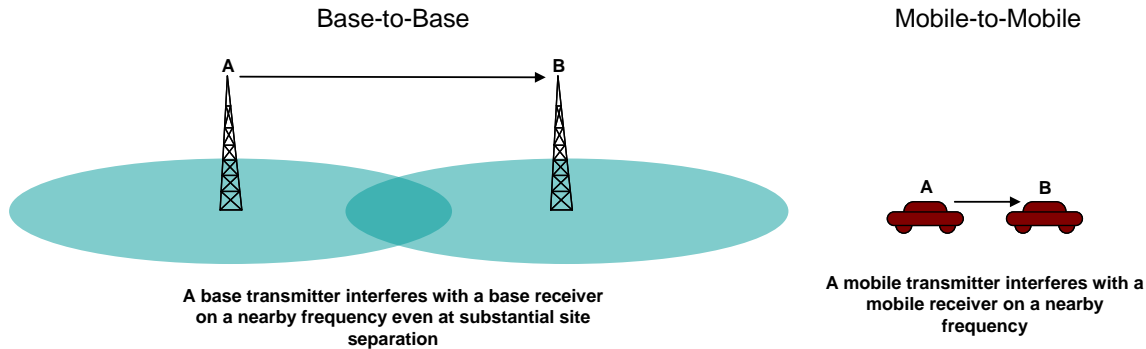

Figure 6 – Interference paths in unpaired spectrum.

In unpaired or TDD spectrum, a base receiver may be on a channel spectrally close or even adjacent to a base receiver at another site. The path loss between two antenna towers may be no more than free-space loss and the antenna may have moderate to substantial gain, depending on the frequency. Thus, even base sites with substantial geographic separation may interfere with each other unless precautions are taken in system design¹³.

Interference can occur between mobile units in unpaired or TDD spectrum, as well. The antenna height of a mobile unit is usually very low so the path loss increases rapidly with distance. However, the transmitter OOB and receiver selectivity of mobile units are usually worse than that of base stations and the separations between mobile units can be as low as a few feet. This can result in mobile-to-mobile interference. The 800 MHz LMR band, with its well-defined base transmit/mobile receiver and mobile transmit/base receive bands, reconfiguration was developed in response to these types of problems.

3.2 NEAR-FAR SCENARIOS

Another common interference scenario involves a receiver being geographically close to an interferer and far from the desired source transmitter. The two near-far scenarios are shown in Figure 7.

In the inbound scenario, a mobile unit (B) physically close (near) to a site and transmitting on an adjacent or spectrally nearby undesired channel interferes with a weak (far) mobile unit (A) transmitting inbound on the desired channel. Alternatively, in the outbound scenario, a mobile unit far from its desired site (A) is interfered with when near another base station transmitting on an adjacent or spectrally nearby undesired channel.

¹³ For unpaired/simplex systems these approaches have been used for decades and include the use of coded squelch (PL) tones. For TDD systems, interference limiting approaches include synchronizing the co channel systems.

These scenarios can result in interference because the range of signal strength in an LMR system can vary on the order of 100 dB. Typical protection ratios are on the order of 60 dB to 80 dB for narrowband systems and 30 dB to 50 dB for cellular technologies. Because systems are generally designed to select the strongest available transmitter site, near-far scenarios occur with relatively low probability. However, since there are so many LMR systems in operation, interference scenarios occur fairly often. Part of the job of spectrum design is to prevent near-far scenarios from occurring, either by frequency coordination in narrowband (noise limited) systems or by sufficient site density in cellular (interference limited) systems.

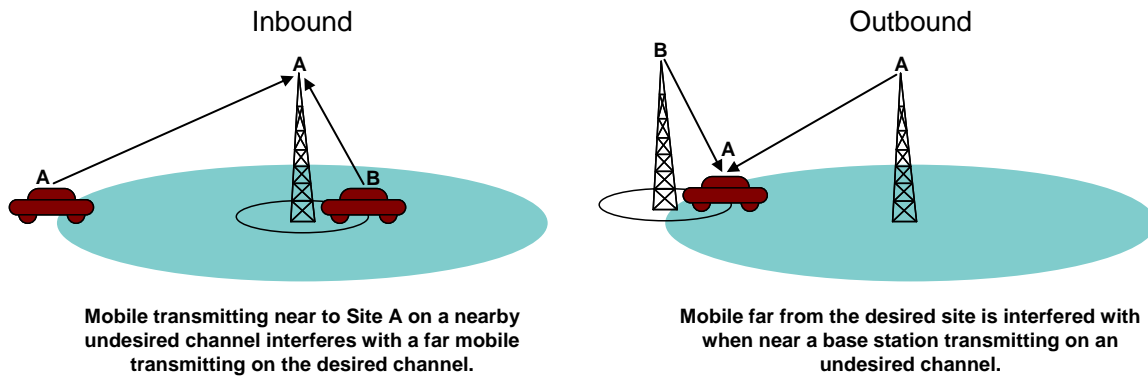

Figure 7 - Near - Far Scenarios

4. EFFECT OF INTERFERENCE

Fundamentally, interference causes a reduction of SNR in a receiver. At a minimum, this reduces the bit rate that can be provided via the affected receiver, may increase the bit error rate and, in some cases, may completely interrupt service. Interference manifests itself in two ways:

1. Some technologies, such as those employing code division multiple access (CDMA) techniques or those employing turbo error correction coding and hybrid retry mechanisms, such as LTE and WiMAX, are designed to operate at positive SNR but regardless, the throughput and capacity of a channel is proportional to the available SNR. As SNR degrades, the capacity of the channel degrades. Therefore, one way to view the impact of interference is as a reduction of system capacity. This is the way cellular operators generally view interference, especially for single frequency reuse systems.
2. Alternatively, interference can be viewed as degradation to system coverage reliability rather than as simply affecting capacity. (This view is generally held by public safety communicators and Federal homeland security, national security, space and aviation operators, regarding mission critical communications.) From this perspective, interference is considered as another source of outage, just like low signal strength is.

In calculating SNR at a location in the coverage area, the interference due to OOBE, intermodulation and interference from any other undesired source are added to the receiver's thermal noise power to determine the total noise power. The desired signal power is then divided by the total noise power resulting in an SNR, which if below a minimally acceptable value indicates that service at the location is not available at the minimally acceptable level. A system's entire service area is analyzed tile-by-tile in this manner and an overall system coverage value is derived. This is the way public safety systems are designed and tested and typical area coverage design values are 95% and 97.5%. This methodology is explained in detail in TIA Telecommunications Systems Bulletin-88-B (TSB-88-B).¹⁴

B. INTERFERENCE MITIGATION TECHNIQUES AND RECOMMENDATIONS

The following section discusses interference mitigation techniques that may be employed to remedy the types of interference described above. Recommendations for each mitigation technique appear at the beginning of each subsection.

Before proceeding with the specific approaches, we would note that an important step in the development of interference avoidance mechanisms is the creation of a spectrum database. We support legislative efforts to conduct a comprehensive inventory of commercial and government spectrum use.¹⁵ It is also important to supplement this allocation and assignment data with information regarding the actual use of the airwaves. Virtually every service to which spectrum is allocated can show a legitimate need for the spectrum, and most incumbents will argue that they make "efficient" or "effective" use of those allocations. Thus, compiling a database of spectrum assignments will be interesting, but that alone will fail to show how much, or even if, the spectrum is actually being utilized. Indeed, a more complete database would include additional information such as temporal duty cycles, active and inactive time periods.¹⁶ The analysis of the inventory information along with any data on the

¹⁴ Wireless Communications Systems – Performance in Noise and Interference – Limited Situations, Recommended Methods for Technology Independent Modeling, Simulation, and Verification, Telecommunications Systems Bulletin, TSB-88-B-1, (TSB-88-B) TIA (2005).

¹⁵ For example, *See* HR 3125 and S 649. The legislation will require NTIA and the FCC to conduct a comprehensive survey of the nation's spectrum resources. It will provide expanded authority and guidance to the FCC and NTIA to work together to create and maintain an accurate, comprehensive database of spectrum allocations, assignments and utilization. Consolidating the available allocation and assignment data from the various repositories into a single, unified portal or database will go a long way toward a better understanding of spectrum.

¹⁶ For purposes of supplementing the consolidated spectrum database, the Commission and NTIA may consider sponsoring or conducting an initial series of spectrum occupancy studies at a diverse set of 10 to 20 fixed locations, augmented by mobile data collections, in urban and rural areas over several days or weeks. Depending on available agency and other financial resources, some or all of this effort could be contracted out to independent third parties, the National Science Foundation or the National Academy of Sciences. These studies would assess the full range of spectral, temporal, spatial, and related issues and variables. Bands with low occupancy and large
(continued on next page)

actual use of spectrum must take into account the purpose for which a spectrum band in question has been originally allocated and the manner in which the particular spectrum band is expected to be used. For example, in some bands, it may be appropriate to look at average spectrum utilization over a given period of time or over a certain geographic area. For other bands, utilization could be based on peak usage levels, especially during times of emergency.

We will first discuss the use of employing guardbands to avoid interference. While this technique requires additional use of spectrum, in some instances it may be the most appropriate measure to avoid interference. Recent developments in DSA will be discussed, including two mechanisms for avoiding interference and improving spectrum sharing opportunities: cognitive radio/spectrum sensing (CR) and the use of a spectrum database combined with geolocation technology.¹⁷

1. Guardband Recommendations

The NTIA, the FCC and other Federal agencies responsible for spectrum management have effectively employed guardbands to avoid interference. Where appropriate, guardbands should continue to be used as a tool to reduce the effects of OOB and adjacent channel interference. They are not necessarily useful in reducing interference for small, low cost devices and have only a modest impact in reducing the effects of receiver-generated intermodulation.

To provide greater certainty with respect to spectrum use rights, and thereby stimulate investment in incumbent communications services, NTIA or any government entity employing guardbands in spectrum policy should be guided by the following principles:

- **For new services, the spectrum used for such a guardband should come from a new service commencing operations and not an incumbent service, if that would be in the public interest.**

spectrum holes (time and frequency) can be checked against the consolidated assignment database (including the predicted transmission patterns for known fixed transmitters) to determine if the signals should have been detectable if they were present. Long-term spectrum observatories could also be set up by the Commission, NTIA, universities and other parties at a variety of locations around the country to provide a steady source of usage data that will validate earlier results, observe trends in spectral usage over longer periods (years), identify usage patterns and anomalies, and confirm the positions of spectral holes in time and space. Spectrum observatories could be a useful spectrum resource management tool.

¹⁷ We also note that there may be other interference avoidance measures that appear to be beyond the scope of this report. For example, we have not examined other measures such as interference-tolerant modulation techniques (e.g., OFDMA) and network architectures that promote cellular reuse.

- **If an incumbent service makes changes to its system’s architecture or modulation technique that results in new interference, then the spectrum to be used to establish any guardband protections should be provided by the service making such changes, if that would be in the public interest.**
- **When allocating spectrum for new services, guardbands should not simply reflect current OOB rules. A realistic assessment of the potential for OOB interference should be analyzed to ensure the size of the guardband is appropriate. This assessment should consider filter performance that is commercially available and performance that can be reasonably expected in the near term.**
- **Where appropriate, “virtual guardbands” using dynamic spectrum access techniques may be considered as an alternative to physical guardbands on a case-by-case basis.**
- **Consistent with the recommendations contained herein, when employing physical guardband techniques, government policy makers may consider whether the equipment to be protected from harmful interference is dated technology that can reasonably be upgraded to mitigate adjacent band interference.**

Discussion:

A guardband is an allocation of spectrum used to separate adjacent transmit and receive bands within a given service or to separate bands of different services for the purpose of protecting operations within the separated bands from interference. The use of guardbands may raise significant policy considerations. For example, should spectrum to be used as a guardband come from an incumbent or new service? Moreover, should new applicants compensate incumbent users for the use of guardband spectrum? While recognizing the need to provide certainty of investment for incumbent services using spectrum, we can envision situations where the public interest may be served by encouraging marketplace negotiations between new and incumbent services. Future reports may want to address the fundamental question of balancing the spectrum rights and investment expectations of incumbent services with the need facilitating new spectrum-based services.

Guardbands allow sideband noise and filter responses to roll off to acceptable levels before entering other bands. The guardband spectrum is typically designated for another type of service that, due to its particular use case, is neither affected by interference from the adjacent bands nor interferes with the adjacent bands. Figure 8 shows the 800 MHz land mobile band and the use of the Aeronautical Mobile band as a guardband between the mobile transmit/base receive and the base transmit/mobile receive bands.

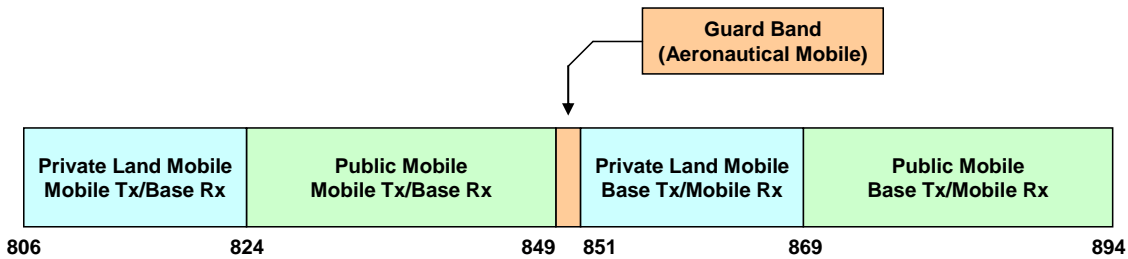

Figure 8 – The 800 MHz land mobile band and associated guardband

The discussion that follows uses the 800 MHz band as an example of the types of interference that can occur. The private LMR band will be referred to as the “PLMR band” and the cellular public mobile band will be referred to as the “cellular band.” We will discuss various approaches to guardbands to address out-of-band emissions¹⁸ and other types of interference.¹⁹ (While these examples are representative of interference involving cellular-type architectures, they do not encompass scenarios that may be more typical for many Federal users, such as operation of non-communications systems (e.g., radars).)

There are practical limits to the ability of a receiver to reject strong off-channel signals and filters are often required to prevent strong off-channel signals from entering receivers. Practical filters require some spectral separation to accommodate filter roll off to reduce out-of-channel signals to levels sufficient to protect the receiver. Thus, a guardband is helpful in that it provides separation for the filter to work. The following section discusses several approaches to guardbands.

1.1 DUPLEX ANTENNA COMBINING

Combining a base station’s transmitter and receiver onto a single antenna is a common practice known as “duplexing.” Because the transmitter’s OOB and the duplexer’s filters need to roll off to prevent the transmitter from interfering with the duplexed receiver, frequency separation is required. In this way, the intervening spectrum can be considered a guardband. Figure 9 shows the duplex scenarios in the 800 MHz band.

¹⁸ Out-of-band emissions are emissions that fall outside the transmitters authorized bandwidth. FCC rules restrict OOB levels to seemingly small levels but because of the high sensitivity of radio receivers even very small OOB levels can cause interference in some circumstances. It appears that many of the FCC’s OOB limits, such as the 43+10 logP attenuation requirement in many licensed services or the limits contained in Part 15 section 209 are not adequate to provide protection. Even the best transmitters require some spectral separation to allow OOB to roll off to acceptable levels. Likewise, practical RF filters require spectral separation to attenuate OOB to acceptable levels.

¹⁹ Intermodulation (IM) products result when strong off-channel signals enter a receiver and are acted upon by non-linear components within the receiver. When the IM products become strong enough, they can interfere with the desired signal.

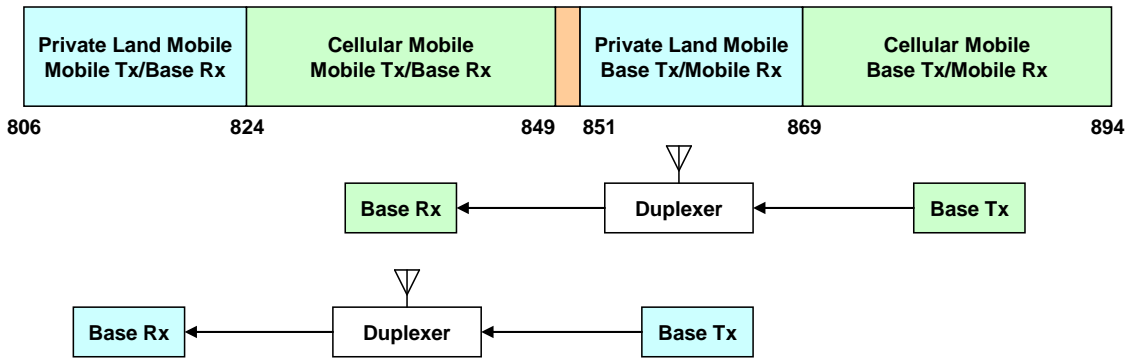

Figure 9 – Duplex scenarios in the 800 MHz band.

In the cases shown in Figure 9, the base transmitters and receivers are coupled to a common antenna through a duplexer, which attenuates the transmitter’s signal and prevents it from entering the receiver to a practical extent. The cellular system uses the PLMR base transmit band as a guardband between its transmit and receive frequencies. Likewise, the PLMR system uses the cellular base receive band as a guardband between its transmit and receive frequencies. In this case, the guardband (849-851 MHz) is also allocated for aeronautical mobile services and does not play a significant role.

1.2 BASE-TO-BASE SCENARIOS

Base-to-base scenarios are demonstrated using the 800 MHz land-mobile band in Figure 10. The primary interference mode in this case is the PLMR base transmitters interfering with cellular base receivers. This is especially problematic because the path loss between base transmitters and base receivers can be essentially free space and there can be high antenna gains at both transmitter and receiver sites.

Two problems result. First, the OOB from the PLMR band must be attenuated sufficiently so that it does not raise the noise floor in the cellular base receivers to an unacceptable level. Second, the strong signals from the PLMR base transmitters can cause IM interference in the cellular base receivers.

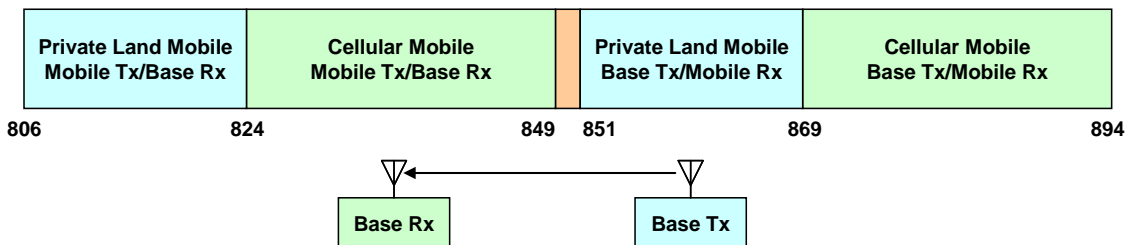

Figure 10 – Base-to-base interference in the 800 MHz band

A 2 MHz guardband is provided in the 800 MHz band. This is a small band but sufficiently wide to allow the use of RF filters of practical size. At base sites, practical filters

can attenuate OOB at the transmitter site and out-of-band signals at the receiver site sufficiently to eliminate interference to a practical extent.

1.3 MOBILE-TO-MOBILE SCENARIOS

Mobile-to-mobile scenarios are demonstrated using the 800 MHz land mobile band in Figure 4. The primary interference mode in this case is the cellular mobile transmitters interfering with PLMR mobile receivers. This can be problematic because the geographic separation between the public and private mobiles can be very small, to the extent that they can be present on the same user, and hence the path loss can be very small.

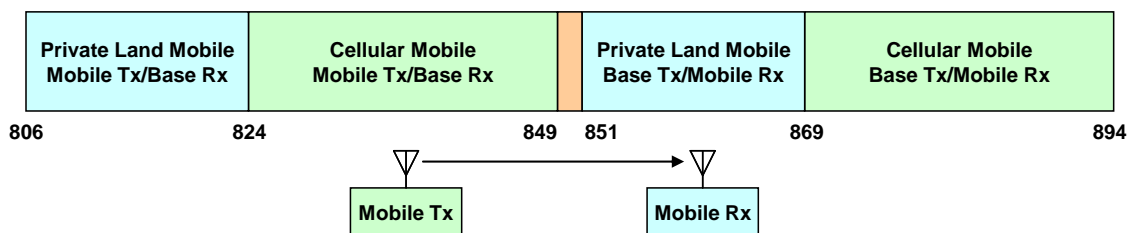

Figure 11 – Mobile-to-mobile interference in the 800 MHz band

The FCC limits on OOB are typically less strict for mobile equipment than for base equipment.²⁰ In addition, the ability of mobile receivers to reject out-of-band signals is typically less than that of base stations, as well. Further, it is not possible for filters of practical size for mobile units, such as SAW filters, to significantly attenuate signals in the 2 MHz guardband provided. Therefore, practical guardbands are less effective at mitigating interference in mobile-to-mobile scenarios.

1.4 BASE-TO-MOBILE AND MOBILE-TO-BASE SCENARIOS

Figure 12 shows base-to-mobile and mobile-to-base scenarios in the 800 MHz band. These scenarios arise because systems from both PLMR and cellular bands are deployed in close proximity to each other, resulting in high signal strengths, particularly near the cellular sites. This has resulted in intermodulation interference in the PLMR mobile receivers in the

²⁰ Because there are situations where a mobile transmitter can be close to a mobile receiver, there may not be a benefit from propagation loss. Applying less strict OOB limits in these situations may give rise to significant problems. Moreover, OOB levels for broadband mobile transmitters must be realistically evaluated. Government spectrum managers should focus greater attention on solutions for these problems. For example, better filtering in transmitters and receivers may be appropriate. However, the size of the filters necessary to resolve these issues, and other hardware limitations, may preclude using filters in some cases.

past. On the other hand, interference from PLMR base transmitters to cellular mobile receivers has not been a significant problem, presumably because PLMR base antennas tend to be on high towers resulting in high path loss between PLMR base transmitters and cellular mobiles. In addition, interference from mobiles to base stations has not been found to be a significant problem.

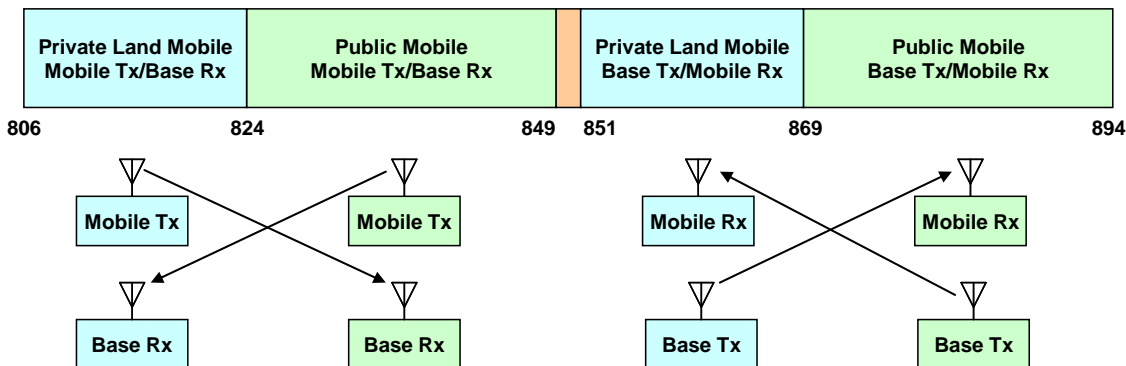

Figure 12 - Base-to-mobile and mobile-to-base scenarios in the 800 MHz band

Note that the aeronautical mobile guardband is not involved in these scenarios at all. The 800 MHz rebanding program currently underway is an attempt to mitigate cellular interference to public safety within the PLMR band by creating an effective guardband between those two services. The following section discusses some of the practical limits of guardbands especially in the context of broadband systems.

1.5 SUMMARY: GUARDBANDS AS AN INTERFERENCE AVOIDANCE TOOL

Guardbands are very effective at reducing the effects of OOB from narrowband systems because the OOB of a narrowband transmitter rolls off significantly in a practical-sized guardband (approximately 1 MHz). Broadband signals have broader OOB spectrums and aggressive filtering is required to substantially reduce OOB with a 1 MHz guardband. Filtering of this order has generally been practical only at base stations. To prevent OOB from 700 MHz C Block LTE mobile transmitters from interfering with public safety mobiles in the 700 MHz public safety block, a special mode was created in the 3GPP standard that results in lower OOB but also reduces throughput. The special mode is under the control of the cellular operator and is turned on through a downlink message on a cell-by-cell basis. However, this is not just a problem between LTE and narrowband public safety; any mobile receivers operating in the 700 MHz spectrum would be affected by the OOB because the 1 MHz guardband between the base and mobile transmit bands is insufficient for significant attenuation of broadband signals. On the other hand, the 1 MHz guardband between Block C and the D/Public Safety Spectrum Trust (PSST) blocks provides sufficient room for filters on the broadband base transmitters to attenuate the base-generated OOB, reducing potential interference near base stations.

Guardbands generally have not helped reduce intermodulation products in mobile units but can help reduce intermodulation in base receivers. The reason for this is that filters that

have been practical for mobile units are relatively broadband, allowing signals from several MHz away to intermodulate in the mobile receiver. On the other hand, physically large filters can be used at the base site to keep large out-of-band signals from entering the receiver and causing IM. Again, because a practical guardband is on the order of 1 MHz, making the guardband larger has a small affect on IM immunity in mobiles unless the guardband was several MHz wide.

Before employing guardband techniques, government spectrum managers should examine whether the technique results in the suboptimum use of spectrum. In this regard, the dynamic spectrum access techniques discussed in this report may, in some circumstances, provide a more spectrally efficient means of preventing interference. Improved filter performance may also prove to be a viable option.

2. Frequency Coordination Recommendations

Frequency coordination has successfully been used by the NTIA, the FCC, other government agencies and private entities to mitigate interference. These efforts have been especially useful in coordinating homogeneous services. However, future coordination is likely to involve more disparate, heterogeneous services, thereby complicating these efforts. In addition to the techniques previously employed, we suggest that the NTIA, the FCC and other government agencies responsible for spectrum management should:

- **Move forward with a complete spectrum inventory to assist all future spectrum coordination efforts.**
- **Recognize that frequency coordination becomes more complex when sharing spectrum with unlicensed devices or devices approved as part of a “blanket licensing” regime, and coordination may be impossible if such devices are “untethered” or not connected to an accurate spectrum database or other management control system.**
- **Understand that the NTIA, the FCC and other government entities managing spectrum may have to play a greater role in frequency coordination, especially where commercial and government entities will share spectrum and also where different commercial services are sharing spectrum.**
- **Utilize private market mechanisms, such as negotiated interference solutions, to facilitate frequency coordination.**

Discussion:

Frequency coordination is an effective method in which a “guard space” is used to separate systems sharing the same spectrum or occupying adjacent spectrum. Coordination is usually thought of as a formal process by which a frequency and a coverage area are assigned

to an applicant. In cellular systems, the frequency re-use pattern is basically an informal approach to coordinating frequencies and controlling interference.

Narrowband systems are typically coordinated by a “coordinator,” an authority designated by the FCC to approve license applications for individual frequency assignments based on the analysis of interference potential and management approaches. The granting of an FCC license usually requires approval from a recognized coordinator. Narrowband spectrum allocations are usually shared by many individual users, each using only a few channels and covering a relatively small operational area (< 30 km radius). Co-channel re-use, and sometimes adjacent channel interference, is either defined by rule or by practice between the coordinators.

On the other hand, cellular operators are granted a license for an exclusive block of spectrum and an exclusive geographic coverage area. Within their operating area and spectrum block, the cellular operator coordinates frequency re-use, coverage, and interference to/from stations and subscribers under their control. At the borders of their operating areas or edges of their spectrum block, the cellular operator has to coordinate coverage and manage interference to/from adjacent spectrum users. This usually involves agreement on edge cell coverage, acceptable interference levels to/from edge cells, width of guardbands, control of out-of-band emissions, etc.²¹

Frequency coordination may also be an effective tool to avoid interference among disparate services. For example, the Commission has often used broadcast frequency coordinators to manage interference between television broadcast stations and entities using wireless microphones. Recently, the broadcast frequency coordinator has been used to manage potential interference between local television stations, wireless microphones and communications systems now used by nuclear power plants.

The efficacy of frequency coordination to avoid interference appears to be limited to situations in which the spectrum users are licensed entities. Such coordination will not be

²¹ For example, several practices have been identified in the public safety-cellular interference experience in the 800 MHz band, which can be used to reduce the impact of cellular interference to public safety operations. These practices may be extended to other interference scenarios, as well:

- Retune cellular channels further away from the public safety operator’s channels
- Modify cellular power levels, antenna height and antenna characteristics
- Assure proper operation of base station equipment
- Improve the local signal strength of the public safety communications system
- Incorporate filters into cellular transmission equipment
- Segregate public safety and cellular spectrum assignments
- Advance planning
- Design public safety equipment to an intensive RF environment
- For system design criteria, design the public safety system to provide adequate in-building coverage to result in a system with less interference on the street

effective if one or more of the entities using spectrum is unlicensed. Because the location and frequencies being used by unlicensed devices may not be available at any one particular time, it will be impossible for a frequency coordinator to manage interference among unlicensed users or between unlicensed and licensed users. Accordingly, the above-stated recommendation recognizes the unique issues presented when sharing with unlicensed operations. The recommendation proposes that in the context of sharing with licensed systems, unlicensed devices be connected or “tethered” to a database and or use some other management control system, such as spectrum sensing technologies. The Subcommittee recognizes that one member of CSMAC disagrees that all unlicensed devices should be “tethered” or connected to a database.²²

Future efforts to provide greater transparency regarding spectrum use will enhance the capabilities of frequency coordinators. For example, establishing a spectrum database will allow a frequency coordinator to develop strategies and frequency assignments to avoid interference. In this regard, all parties relying on frequency coordinators will benefit from the creation of an accurate database.

We recognize that increased sharing between government and commercial users may necessitate greater government involvement in frequency coordination. Similarly, frequency coordination among disparate commercial enterprises may require a level of government oversight that is not necessary when coordinating among like services. Nonetheless, for government oversight to be effective, it must significantly improve its abilities to respond quickly and manage spectrum dynamically.

To the extent possible, we believe the government should look toward market mechanisms in developing frequency coordination models. For example, the government may look toward negotiated interference rights to coordinate various communications services. Various forms of negotiated interference rights have worked well in the cellular and broadcast industry. In most instances, such processes have been able to resolve interference issues more quickly and with less disruption to consumers.

3. Dynamic Spectrum Access Recommendations

Recent developments in DSA may offer new opportunities to increase spectrum sharing options, but may have certain limitations depending on potential interference scenarios that are associated with different radio services.

²² As an alternative, one member suggests that we delete the recommendation concerning “tethering” of unlicensed devices and insert in its place the following recommendation:

Utilize spectrum database and other management control systems to enable coordinating unlicensed devices in band where coordination of such unlicensed devices was previously impossible.

Sound spectrum policy requires a realistic assessment of the interference avoidance mechanisms of DSA techniques, through additional testing and evaluation, including NTIA's ongoing Test-Bed initiative.

Cognitive Radio and Spectrum Sensing Technology

Cognitive radio and spectrum sensing technologies may become an important tool in spectrum sharing policies in the future. NTIA, the FCC and other government entities responsible for spectrum management should:

- Establish procedures that examine the efficacy of spectrum sensing devices to protect services that employ different system architectures and modulation systems.
- Ensure that such technologies, like any new or existing radiofrequency (RF) device, comply with existing transmitter and/or receiver regulations applicable to the various services that may occupy those frequencies. Nonetheless, the adaptive capabilities of these technologies may create challenges to mitigating interference and will need to be examined as they become available.
- Examine the application of this technology as a sharing and interference avoidance tool on a case-by-case basis for each radio service as DSA technology becomes available, because cognitive radio and spectrum sensing technologies may create unique interference challenges to different system architectures. Examples include certain safety-of-life bands (e.g., GPS and public safety) and services (e.g., passive radio astronomy and broadcasting).
- While additional research is always important, government efforts should focus on testing and evaluation to ensure that such technology will develop properly and not lead to interference. Further field and laboratory testing is necessary in the following areas:
 - The efficacy of spectrum sensing devices to protect other fixed, mobile and portable devices from all types of interference.
 - The potential for interference due to a DSA device's potential inability to sense an occupied channel due to a "hidden node."
 - The ability of the DSA device to sense signals at low enough levels to protect other spectrum users without producing substantial "false alarms" to render the devices useless.
 - The ability of the entire DSA system to effectively prevent interference. For example, the effect of antennas on the ability of a device to adequately receive/sense a signal from an existing spectrum user should be examined.
 - Examinations should include how an actual DSA device will operate in its environment as part of the communications ecosystem.
- The NTIA, the FCC and any other government entities responsible for spectrum management should increase significantly the resources directed to

provide further testing, evaluation and development consistent with the above recommendations. Several sources of funding should be explored including and increase in Congressional appropriations, auction revenues or appropriate spectrum fees that are consistent with the cost of regulation.

- The NTIA and the FCC should also explore cooperative real time spectrum sharing arrangements in which the primary user actively signals the sharing party about both real time spectrum availability and near term projections.

Database and Geolocation Approaches

In general, the creation of a spectrum database is essential to provide spectrum managers with information necessary for future spectrum planning. Consistent with the goal of spectrum inventory legislation, the NTIA, the FCC and other government spectrum managers should examine actual usage of spectrum assigned to government and commercial entities. We support current legislative and government efforts to inventory spectrum use by commercial and government entities.

In its most comprehensive form, a database – when combined with a geolocation system – may provide a mechanism to facilitate spectrum sharing. As part of the government’s efforts to conduct an overall spectrum inventory, government entities managing spectrum should complete a comprehensive spectrum inventory for the frequencies on which sharing is proposed, to ensure that a database system effectively mitigates interference.

- When developing a comprehensive database to facilitate spectrum sharing, the NTIA, the FCC, government agencies and other entities managing spectrum on behalf of the government should:
 - Construct the database so it can provide accurate information regarding spectrum use in real time, where feasible. In creating this database, government spectrum managers must develop specific metrics, which define spectrum use. Such an examination should involve determining what constitutes a usable signal. For example, this could be arrived at by specific signal measurements or use of predictive models that define protected service areas. Use may also be defined not only in terms of geographic areas, but also in terms of time and duration.
 - Maintain administrative control over the database or distribution of the database where government spectrum is involved or in cases where government spectrum will be shared.
 - To the extent a government agency delegates the creation and maintenance of a database to any private entity, the government should enact policies to maintain direct oversight over all aspects of the database management including, information distribution to database administrators, spectrum managers and devices relying on database information.

- Where appropriate, database information should be made available to the public to provide transparency and proper oversight. Such access must be consistent with concerns regarding national security. From an operational standpoint, however, government spectrum managers may find it appropriate to limit real time access to database information to those devices that have been certified or approved to use the database by the NTIA, the FCC or an appropriate government entity. In the interest of transparency, provisions may be made to allow for non-real time access by other parties interested in improving spectrum utilization. If the data contains sensitive details about national security, the non-real time access might contain aggregated data that protects sensitive details.
- All DSA devices relying on or using the database must receive an appropriate authorization code to the database or database administrator before transmitting on any frequency. Where feasible, such authorization shall be updated continuously. Should a device fail to receive an authorization code or signal, it will cease operation on the frequencies assigned by the database.
- Adopt specific end-to-end security to ensure that only authorized DSA devices are able to access database information and prevent the database from being “hacked.”
- Ensure the technical security of the database and all devices using the database. A database approach may not be appropriate for sharing spectrum with DSA devices that are classified.
- DSA devices relying on a database to avoid interference should be capable of being turned off remotely in a timely manner, if they are causing interference. Interfering devices shall cease operation on those frequencies causing interference while resolving bona fide interference complaints. Complaints should be resolved within 30 days.
- Provide for equal participation by incumbent users and new users in the establishment and maintenance of any databases and where appropriate, participation by third parties.
- Place primary emphasis on protecting existing services from additional harmful interference.
- Consider the types of DSA system architectures and devices that will rely on the database. While in some cases a database can be used for both fixed and mobile devices, there may be scenarios (or bands) where a database is not appropriate for mobile and portable systems.

Sound spectrum policy may benefit from the use of both cognitive radio and database systems. In addition, data gleaned from cognitive radio/sensing technology may become an important component in ensuring the accuracy of a database system.

Resources should be devoted to additional research regarding the use of databases to provide additional sharing opportunities. For example, future database approaches may include not only geographic coverage information, but other factors such as the time of day spectrum is being used.

Discussion:

DSA may offer new opportunities to facilitate spectrum sharing and the more efficient use of spectrum. To date, DSA proposals have focused on two approaches. The first relies on cognitive radio technologies, which sense their environment, and avoid operating on occupied channels. The second involves a combination of database and geolocation systems. Using predictive models, this approach avoids interference by telling a device which channels are “vacant,” hence usable, in a particular geographic area. Each approach has its strengths and weaknesses. Application of either technology to avoid interference will depend on a number of factors, including the nature of incumbent uses as well as new services that are anticipated to use the spectrum in the future. In some instances, it may be appropriate to require utilization of both interference avoidance methods to mitigate potential interference.²³ To the extent DSA techniques become effective tools, they potentially may obviate the need for traditional reallocation policies and procedures, which can take years. For example, rather than constantly disrupting existing services by reallocating incumbent systems, the use of DSA techniques can achieve the goal of providing more efficient use of spectrum, especially in the context of wireless broadband systems.

3.1 EMERGING RADIO AND NETWORK TECHNOLOGIES

A number of radio and wireless networking technologies are emerging that “create many new avenues for improving use and access to the radio spectrum. Specifically, they provide additional degrees of freedom that allow a device to choose the best method of spectrum access for a particular situation and to subsequently alter the method of access in response to changing conditions. For example, DSA systems have been suggested as a fundamental, technology-enabled method to make more effective and efficient use of scarce available spectrum: “[The] DSA concept advocates empowering radio systems with the local authority and responsibility to manage available spectrum.”²⁴

While this technology holds significant promise, it is also worth noting: (1) The potential drawbacks with respect to timing, in terms of near-term versus longer-term opportunities and (2) Issues that remain to be more fully addressed with respect to interference, security and other areas of potential concern. The recent report of the Aspen Institute Communications and Society Program, “Rethinking Spectrum Policy: A Fiber Intensive Wireless Future,” noted that participants in the Aspen Institute’s annual spectrum conference concluded that cognitive radios have long-term potential for increasing spectrum capacity for unlicensed spectrum. However, the report noted: “There was substantial agreement that these

²³ For example, when disparate services sharing spectrum have both a fixed and mobile component, employing spectrum sensing and database technologies may be necessary to prevent interference to both types of operations including incumbents and new services.

²⁴ IEEE 1900.1, *IEEE Standard Definitions and Concepts for Dynamic Spectrum Access: Terminology Relating to Emerging Wireless Networks, System Functionality, and Spectrum Management*, IEEE Communications Society, September 26, 2008, Page v.

devices are several years away from actual deployment. Participants agreed that the technology is still evolving and it is not where it needs to be at the moment. Some suggested a timeline of 10 to 12 years for significant improvements. In addition, the participants agreed that a critical enabler for increased use of this technology is the development and implementation of appropriate enforcement mechanisms to protect incumbent authorized users.”²⁵ The following section focuses primarily on DSA and related subjects.²⁶

3.2 DSA COGNITIVE RADIO TECHNOLOGY AND SENSING

3.2.1 DSA Overview

DSA technology enables RF devices to continually and autonomously assess the radio spectrum environment, and automatically (i.e., without human intervention) and swiftly adjust operating frequencies to accommodate changing capacity/interference conditions. In other words, DSA makes wireless network operations frequency agile. DSA radios are able to do this without interfering with “non-cooperative” radios and in accordance with user-defined policies. This is all accomplished via a novel combination of RF, signal processing, networking, and detection technologies coupled with DSA software/algorithms that can increase use efficiency to provide an order of magnitude more communications capacity than is achieved today using fixed static spectrum access practices.

²⁵ Aspen Institute Communications and Society Program, “Rethinking Spectrum Policy: A Fiber Intensive Wireless Future,” 2010, page 4, at: aspeninstitute.org/sites/default/files/content/upload/Rethinking_Spectrum_Policy.pdf.

²⁶ This section includes selected definitions from the IEEE DSA Networks Standards Coordinating Committee (SSC-41) that are useful in understanding the sections that follow.

- Cognitive Radio (CR) – “A type of radio in which communication systems are aware of their environment and internal state and can make decisions about their radio operating behavior based on that information and predefined objectives.” This includes a CR “that uses software-defined radio, adaptive radio, and other technologies to adjust automatically its behavior or operations to achieve desired objectives.”
- DSA – “[The] real-time adjustment of Spectrum Utilization in response to changing circumstances and objectives. Changing circumstances and objectives include (and are not limited to) energy-conservation, changes of the radio’s state (operational mode, battery life, location, etc.), interference-avoidance (either suffered or inflicted), changes in environmental/external constraints (spectrum, propagation, operational policies, etc.), spectrum-usage efficiency targets, Quality of Service (Quos), graceful degradation guidelines and maximization of radio lifetime.”
- Frequency Agility – “The ability of a radio to change its operating frequency automatically; typically these changes are rapid or span a wide frequency range or have both of these change characteristics.”
- Policy-based control mechanism (Policy) – “A mechanism that governs radio behavior by sets of rules, expressed in a machine-readable format, that are independent of the radio implementation regardless of whether the radio implementation is in hardware or software.”
- Software Defined Radio – “A type of radio in which some or all of the physical layer functions are software defined”²⁶ (i.e., implemented and/or altered in software). Physical functions include things like frequency range, modulation type and output power.

DSA's Potential

DSA's promise is to improve spectrum utilization in three dimensions: frequency, location and time. It enables a network to opportunistically use any available channel (frequency) at points in time and space when and where they are not in use, and automatically move to another channel when policy demands it or a primary user/signal appears on the current channel. Because most RF channels are utilized only a small portion of the time and in a fraction of locations, DSA enables two or more applications/networks to share a given band. Among other things, this allows a licensee to deploy more than one application/service in a given band; a primary and one or more secondary networks to cooperatively share a band; and a host of non-cooperative networks to reside within a DSA band. Using DSA, wireless service providers can better utilize their spectrum assets; new market entrants can gain access to spectrum that was previously unavailable; and regulators can enact policies to ensure that spectrum licensees/incumbents are protected when cognitive radio technologies are adopted.

DSA is facilitated by measurement, control and policy-based management software that reside in radios. The software continually assesses the radio spectrum environment and selects the best available frequency based on ongoing measurements and policy restrictions/rules. On the XG project, DSA was implemented on four radios – an 802.16-based prototype radio, an 802.11-based prototype radio, and two legacy push-to-talk (PTT) radios. The software is now being ported onto a number of legacy and emerging Department of Defense (DoD) broadband radio platforms (e.g., Joint Tactical Radio System [JTRS], Enhanced Position Location Reporting System [EPLRS], etc.).

The DSA system architecture consists of four principal components: a DSA engine; an environmental sensing (i.e., detection) subsystem; a communications (i.e., radio) subsystem; and a policy module/enforcer. The DSA engine forms the heart of the DSA system. Among other functions, at each network node the DSA engine manages the operation of the detectors (sensors), maintains a list of candidate channels, and manages the “rendezvous” process of network discovery and frequency negotiation with other nodes.

The DSA engine's policy module can embody the operating rules established by the regulatory body where the radio operates. The regulatory rules can be designed with interference in mind. A DSA radio's conformance to the regulatory rules by the DSA engine provides a baseline in ensuring it operates within acceptable interference parameters.

Potential Security Issues

However, DSA radios and networks still require additional study and maturity before they are ready for wider-scale deployment.²⁷ Researchers and academics have been studying

²⁷ Premature regulatory assessments in this area could become self-fulfilling prophecies, because the private sector may be reluctant to invest in a technology with significant regulatory uncertainty. Thus clear regulatory goals for DSA performance could encourage capital formation for this technology and speed its introduction on a level playing field with other technologies.

potential security issues with the implementation of DSA networks. They have identified numerous vulnerabilities at the physical layer that may require technical or regulatory changes prior to more widespread use. A user may exploit certain vulnerabilities to monopolize use of the spectrum, initiate denial of service attacks, or to eavesdrop on communications. In various studies of security issues, researchers have proposed solutions to address these problems. In order for DSA networks to reach implementation, these issues must be addressed to provide for the efficiency gains that DSA promises.

- One scenario that concerns researchers is where a selfish or greedy user exploits DSA rules to monopolize available spectrum.²⁸ Researchers have suggested the use of a band manager or a registration process to provide some checks to limit a radio's ability to monopolize. Use of economic incentives or penalties may curb this type of behavior.²⁹ In a greedy user scenario, the device causes interference to other users within the confines of DSA rules and not through radio communications.
- Researchers have also identified the potential for malicious users to initiate denial of service attacks or to eavesdrop or intercept communications and have offered various solutions. One researcher found that the majority of cognitive radio DSA implementations are unable to minimize disruption to primary users while making efficient utilization of the vacant spectrum bands when a malicious user is introduced into the environment.³⁰ For example, a malicious user may spoof a legitimate secondary user to either disrupt the primary users' use or to prevent other secondary users' use of vacant spectrum. Researchers have identified some strategies to mitigate these problems including, modifying the modulation scheme, employing proactive detection and prevention methods, or using authentication and trust models. Malicious users may also use spoofing to eavesdrop on communications or to modify data being sent back and forth in the communications process. Similar strategies to prevent denial of service attacks may be employed to protect against eavesdropping or data manipulation.

These examples point to only a few of the security issues that a DSA network may face. Researchers have identified attacks on spectrum mobility, spectrum management, against the learning engine, and on spectrum sharing to degrade or interfere with valid use of a DSA network as possible security targets.

²⁸ Zhu Han, Charles Pandean, and K. J. Ray Liu, Distributive Opportunistic Spectrum Access for Cognitive Radio using Correlated Equilibrium and No-regret Learning, March 2007, available at http://www.cspl.umd.edu/sig/publications/Han_WCNC_200703.pdf

²⁹ Zhu Ji and K. J. Ray Liu, Multi-Stage Pricing Game for Collusion-Resistant Dynamic Spectrum Allocation, IEEE JOURNAL ON SELECTED AREAS IN COMMUNICATIONS, Vol. 26 No. 1, January 2008, http://www.cspl.umd.edu/sig/publications/ji_JSAC_200801.pdf,

³⁰ Saman T. Zargar, Member, IEEE, Martin B. H. Weiss, Carlos E. Caicedo, Member, IEEE, and James B. D. Joshi, Member, IEEE, Security in Dynamic Spectrum Access Systems: A Survey, http://d-scholarship.pitt.edu/2823/1/SecurityInDSASystems_A_Survey_JSAC.pdf.

DARPA Efforts

In 2002, the U.S. Defense Advanced Research Projects Agency (DARPA) became the first entity to begin developing a DSA solution as part of its next Generation (XG) radio program. The radios developed through the XG program include software defined, frequency agile, cognitive and policy capabilities. While an increasing number of companies have begun researching the development of DSA solutions in the past few years, DARPA's technology currently represents the state of the art and, as a result, is described herein.

However, work on DSA pre-dates recent developments by DARPA. Early wireless data networks employed primitive types of dynamic spectrum access techniques for interference avoidance. The ALOHA and Carrier Sense Multiple Access (CSMA) protocols are two that are still widely used today. The ALOHA protocol provides for a back-off period if a sending device detects that its transmission has been interfered with due to a collision with another transmission. After the back-off period, the sender attempts to resend the transmission. The CSMA protocol is a more efficient technique used in the 802.11 family of wireless networking technologies. CSMA employs a channel access mechanism that senses the in-channel power prior to transmitting. If it measures above a certain threshold, it waits for a random back-off period and tries again. This "listen before talk" protocol is coupled with detection avoidance where radios signal their intent to transmit.

A later dynamic access approach was authorized in the 5 GHz U-NII band which required devices employ dynamic frequency selection (DFS) to avoid interfering with incumbent radars. DFS dynamically instructs a transmitter, such as an 802.11 radio, to switch to another channel whenever it detects the presence of a radar signal.

3.2.2 DSA State of the Art

The following subsections describe the DSA state of the art across the DoD and commercial sectors.

DoD

The DoD DSA solution described above is the most advanced solution available today. The technology successfully completed all three phases of DARPA's XG R&D project and is currently being ported onto legacy (EPLRS) and emerging (JTRS, Mobile Ad hoc Interoperability Network Gateway [MAINGATE] and Wireless Network After Next [WNaN]) DoD radio platforms in an effort to demonstrate and test DSA in 2012. The following sections briefly describe DoD field testing efforts and porting projects.

DSA Field Evaluations

All DoD DSA field testing to date was conducted using XG radios developed by Shared Spectrum Company (SSC). Seven major field evaluations occurred between 2006 and 2008. These were witnessed by hundreds of guests including representatives from the DoD, various government agencies, and private entities. Among other things, testing demonstrated

DSA performance in the presence of legacy radio systems, policy control software, and performance in the presence of intentional interference.

The first test occurred in April 2006, and demonstrated, for the first time, a network of DSA radios capable of using spectrum over a wide range of frequencies on a secondary basis. Three two-node DSA networks sensed radio signals from primary users over a wide range of frequencies (225-600 MHz), and operated on the unused channels. Existing legacy radios worked in multiple-network environments without interference from the DSA cognitive radios. Policy-based enforcement was used to operate in distinct frequency bands as permitted by DoD frequency managers in conjunction with FCC Special Temporary Authorizations (STA). All test goals were achieved including, but not limited to, fast Channel Abandonment Times and other “no harm” criteria. A five second Network Join Time, less-than 200msec Network Re-Establishment Time, and the lack of pre-assigned frequencies demonstrated that a DSA system can effectively network with multiple nodes. (In other words, DSA works.) The DSA networks also demonstrated the ability to support a variety of traffic loads ranging from low-bit-rate data up to streaming video.

In a separate evaluation, SSC’s policy control software was successfully demonstrated. SSC’s policy module ensures that third party (e.g., regulators like the FCC, service providers, etc.) spectrum access constraints can be readily loaded onto a network of DSA radios and automatically adhered to. Policies were demonstrated that captured essential features of two classes of representative data inputs: geographic and received signal power from non-cooperative radios. DSA radios were shown to: conform to policies that restricted communications within particular geographic areas (designated by their GPS coordinates) and determine which channels were available in which areas; conform to policies that restricted communications when non-cooperative radios were detected on particular frequencies; and, integrate these policies at run-time, prioritizing them coherently and applying them to radio network operation.

In a third demonstration, a DSA network was shown, among other things, to perform in the presence of intentional interference. Three types of DSA radios were demonstrated: an 802.16-based data radio that was built by SSC; and two legacy PTT handheld radios. The 802.16 radios communicated broadband data, and the PTT radios were chosen to demonstrate the maximum amount of DSA functionality without making any hardware changes to the radios. The field evaluations/demonstrations showed that all three radio types co-existed with a system generating intentional interference. This was proven in every demonstration scenario. Without DSA software, each radio type had minimal transmission range. With DSA software, each radio type provided operationally significant transmission ranges in the interference environment.

DoD Commercialization

As noted above, DoD is currently porting the XG DSA code onto the following radio platforms in an effort to demonstrate and test the technology in 2012.³¹

- EPLRS – Raytheon’s EPLRS is a legacy (i.e., existing), software programmable, broadband wireless tactical radio system. Field testing of DSA-enabled EPLRS radios is scheduled to begin in June 2010.
- WNaN – DARPA’s WNaN project is an effort to develop a new, low-cost (\$500) frequency-agile tactical radio and associated network that can scale to large numbers of devices. Radio evaluations are schedule to begin in June 2010.
- JTRS –JTRS is the future software-defined tactical radio system being developed for the US Army. DSA is currently being ported onto the Boeing radio platform.
- MAINGATE – The Mobile Ad hoc Interoperability Network Gateway (MAINGATE) program is creating a radio gateway that enables legacy analog and digital communications systems to be interconnected into a heterogeneous, IP-based network. Field testing of DSA-enabled radios is scheduled to begin in June 2010.

However, Federal government evaluation of DSA opportunities is not limited to DoD. The NTIA and the FCC, for example, have established a Spectrum Sharing Innovation Test-Bed pilot project to assess the feasibility of increased sharing between Federal and non-Federal users, including via DSA devices using spectrum sensing and/or geolocation techniques to share spectrum LMR systems operating at 410-420 MHz band.

TV White Spaces

On November 4, 2008, the FCC adopted rules allowing “unlicensed radio transmitters to operate in the broadcast television spectrum at locations where that spectrum is not being used by licensed services.”³² Unused TV spectrum is also known as “white spaces.” The FCC’s Report and Order required that white space devices have a geolocation capability and the ability to access (via the Internet) a database of channels that may be used within a geographic location. The Report and Order also required that devices have the capability to “sense TV broadcasting and wireless microphone signals as a further means to minimize potential interference.”³³

In the months leading up to their Report and Order, the FCC conducted two rounds of white space device testing to assess the state of technology. These tests were conducted in the summer of 2007 and the fall of 2008. Two vendors submitted equipment for evaluation in

³¹ Information provided on these programs is intentionally limited given their sensitive nature.

³² *FCC Report and Order and Memorandum Opinion and Order*, FCC 08-260, November 14, 2008, Page 2.

³³ *Ibid*, Page 2.

2007 (Microsoft and Philips), and five companies submitted equipment in 2008 (Microsoft, Philips, Motorola, Adaptrum, and the Institute for Infocomm Research (I2R)).³⁴

None of the devices submitted for the two tests were considered consumer grade devices; rather they were all prototypes/development tools meant to evaluate the viability of spectrum sensing. Of the five devices tested in the fall of 2008: all had TV sensing capabilities; three had wireless microphone sensing capabilities (i.e., the devices from Microsoft, Philips and I2R); one (Adaptrum's) had a transmit capability (though it was not tested by the FCC in the fully automated mode and linked to its own sensing capabilities); and one (Motorola's) had a geolocation/database access capability.

Testing during the fall of 2008 included both lab and field tests of TV broadcast signal sensing capabilities, wireless microphone sensing capabilities, and (for one device) limited transmitter characterization and interference potential testing. Among other results:

- In the lab, all of the devices were able to reliably detect the presence of clean digital TV (DTV) signals on a single channel at low signal levels, but varied in their detection abilities when sensing signals recorded off-the-air that contained real-world distortions. Importantly, these laboratory examinations were “conductive” tests in which signal data was imputed into the device directly. The laboratory tests did not involve “sensing” an over-the-air signal using an antenna.
- In the lab, the presence of moderate-to-strong signals in the first adjacent channel “severely impacted” each device’s detection threshold sensitivity. Adjacent channel signals also affected the ability of devices to reliably detect microphone signals.
- The field tests yielded less than optimal results. The four devices tested in the field usually correctly reported channels as occupied. Nonetheless, all four devices failed to correctly report channels as occupied on all occasions when inside a service contour and where viewable signals were observed on typical TV receivers. There was variation in performance among devices. Some of the devices incorrectly reported some channels as unoccupied while all of the devices reported some false positives (i.e., cases where a DTV signal was indicated when none was present). The Motorola device, when employing geolocation/database capabilities, correctly reported all occupied channels when inside TV station service contours.
- Wireless microphone testing was performed at two field locations on two devices with suboptimal results. One device reported a wireless microphone on every channel it sensed, whether a microphone was transmitting or not. The other device indicated several channels as available despite a microphone transmitting on those channels.

Despite documenting problems in the field with the prototype devices, at the conclusion of testing, the FCC’s Office of Engineering and Technology (OET) noted that the burden of

³⁴ A complete summary of the FCC’s test results can be found in reports issued by the FCC on July 31, 2007 and October 15, 2008. The devices submitted by Microsoft ceased to function properly during the testing process.

“proof of concept” was met. Nonetheless, the Commission refrained from permitting devices that relied exclusively on “sensing” to enter the market. Rather, it required that a combination of spectrum sensing and geolocation/database lookup would allow unlicensed devices to share TV broadcast bands. Additional certification tests, both laboratory and field tests, would be required for any device that relied exclusively on sensing. The OET also noted that its tests were non-exhaustive and meant only to provide additional information for the FCC’s use in making its final white space decision.

Recently, the Federal Communications Commission issued its Reconsideration decision in the TV white spaces proceeding.³⁵ In this decision, the Commission eliminated the requirement that TV white space devices must contain both geolocation and sensing capabilities. Instead, TV white space devices must employ a database and geolocation system to avoid interfering with TV reception and “venue” protected wireless microphones. Nonetheless, the Commission recognized that dynamic spectrum sensing technologies were improving and encouraged further development.

“While we are eliminating spectrum sensing for TVBDS that use geo-location and database access, we continue to believe that this technology offers significant promise for improving spectrum access and efficiency both in the TV bands and providing access to other spectrum.”³⁶

We note that a number of private companies are working to develop TV white space solutions in addition to those who participated in the FCC’s white space device tests. These companies range from large, well-known companies like Google to startup companies that are working to develop solutions targeting specific white space applications. The description and maturity of many of these solutions have generally not been disclosed to the public.

NTIA Spectrum Sharing Test-Bed Pilot Program

The NTIA, in coordination with the FCC and Federal agencies, has established a Spectrum Sharing Innovation Test-Bed (Test-Bed) pilot program to examine the feasibility of increased sharing between Federal and non-Federal users. This pilot program is an opportunity for Federal agencies to work cooperatively with industry, researchers, and academia to examine objectively new technologies that can improve management of the nation’s airwaves.

The Test-Bed pilot program will evaluate the ability of DSA devices employing spectrum sensing and/or geolocation techniques to share spectrum with LMR systems

³⁵ Unlicensed Operation in the TV Broadcast Bands, Second memorandum Opinion and Order, ET Docket Nos. 04-186 and 02-380, FCC 10-174 (adopted September 23, 2010)

³⁶ *Id* at 27.

operating in the 410-420 MHz Federal band and in the 470-512 MHz non-Federal band.³⁷ To address potential interference to incumbent LMR spectrum users, the Test-Bed pilot program will include both laboratory and field measurements performed in three phases to characterize the interaction with DSA enabled devices:

Phase I – Equipment Characterization. Equipment employing DSA techniques will be sent to the NTIA’s ITS in Boulder, Colorado to undergo characterization measurements of the DSA capabilities in response to simulated environmental signals.

Phase II – Evaluation of Capabilities. After successful completion of Phase I, the DSA spectrum sensing and/or geolocation capabilities of the equipment will be examined in the geographic area of the Test-Bed.

Phase III – Field Operation Evaluation. After successful completion of Phase II, the DSA equipment will be permitted to transmit in an actual RF signal environment. An automatic signal logging capability will be used during operation of the Test-Bed to help resolve interference events if they occur. A point-of-contact will also be established to stop Test-Bed operations if interference is reported.

The NTIA Test-Bed is an important step. Nonetheless, there is no widely recognized DSA Test-Bed and associated test plan that clearly outlines performance criteria to be measured; adheres to an aggressive schedule; and delineates what incentives participants will receive for participating in the Test-Bed and meeting the performance criteria. The lack of a clear statement of what the NTIA considers a minimum goal for performance for DSA systems, as well as an explicit timetable may be a disincentive for private investment in this technology because market access timing is both undefined and isolated from the control of the developer. The results of a Test-Bed could go a long way towards providing important information regarding spectrum-sharing technologies.

Other Activities

There are a host of other applications for DSA technology that go beyond tactical communications networks and TV white space devices. These include, but are not limited to, cellular network capacity improvement, rural broadband Internet access, femtocell frequency planning, backhaul link performance improvement, and public safety device interoperability.

³⁷ DSA technology allows a radio device to (i) evaluate its radio frequency environment using spectrum sensing, geolocation, or a combination of spectrum sensing and geolocation techniques, (ii) determine which frequencies are available for use on a non-interference basis, and (iii) reconfigure itself to operate on the identified frequencies.

What companies are doing in these areas is advertised far less than what is happening in the DoD and with white spaces and, therefore, is less well known.

It's also important to note that different approaches to spectrum sharing are being developed (e.g., sensing based, database controlled, etc.) and it's unclear which one will emerge as the standard upon which vendors can design applications/devices. On the DoD side, XG appears to be emerging as the de facto DSA solution. On the commercial side, things are less clear and most of the focus has centered on TV white spaces. Regardless, significant progress has been made in various industry forums towards standardization including the IEEE (SCC41, 802.16h, 802.11y, 802.22), the Wireless Innovation Forum (formerly the SDR Forum), and the Cognitive Networking Alliance (CogNeA), which recently released its Revision 1.0. In addition, forums like DySPAN (the IEEE's Dynamic Spectrum Access Networks symposium) have emerged to serve as events where information on emerging wireless technologies like DSA is exchanged.

3.2.3 DSA Cognitive Radio and Sensing: Regulatory Situation

At the present time, the FCC has before it several Petitions for Reconsideration in the TV White Space proceeding. Earlier this year, OET issued a Public Notice soliciting comment on the selection of a database administrator. Recently, the FCC reached a decision to move a wireless microphone from the 700 MHz band to the current TV band, channels 2-51. As part of this decision, the FCC issued a Further Notice of Proposed Rulemaking soliciting comment on the regulatory status of these microphones, including their ability to be protected in the FCC proposed database. The Commission announced recently its intention to address these issues sometime during the third quarter.

At the same time DSA was being developed and tested, the regulatory environment at the FCC was evolving favorably to support DSA-enabled "smart" or "cognitive" radios through flexible service rules, secondary market policies, and lower entry barriers in many licensed and unlicensed bands, including the so-called TV "White Space." Similarly, NTIA's Federal frequency management regulations now enable systems using cognitive radio or software defined radio technologies in any radio communications service so long as they operate in accordance with the applicable restrictions governing those services. NTIA's 2008 Federal Strategic Spectrum Plan also acknowledged that Federal spectrum requirements necessitate a new, evolutionary model for spectrum management that will provide the means to meet the increasing demand of Federal users through dynamic spectrum access to bandwidth – wherever required, whenever required. More recently, Assistant Secretary of Commerce for Communications and Information, Lawrence Strickling, told a DoD Spectrum Symposium that NTIA has "high hopes for dynamic spectrum access and related innovations to make spectrum use as efficient as possible and to solve the challenges presented when different users and different devices are trying to operate in the same frequency band."³⁸ Finally, the Obama Administration recently voiced its commitment "to supporting research that will foster the next

³⁸ Remarks of Assistant Secretary of Commerce, Lawrence Strickling, at the 2009 DOD Spectrum Symposium (Arlington, VA, Oct. 14, 2009) (As Prepared for Delivery).

wave of innovation in information and communications technologies, such as ‘cognitive radio,’ that allows for the efficient sharing of spectrum....”³⁹

3.3 DATABASE AND GEOLOCATION APPROACHES

Another approach to DSA is the use of a database combined with geolocation systems. Geolocation databases have been proposed to address a variety of spectrum sharing issues. Most recently, the FCC has mandated the use of geolocation databases for the secondary usage of the TV bands by unlicensed devices.⁴⁰ The FCC and others have proposed extending these same concepts to other bands (e.g., for use of government spectrum).⁴¹ In general, a database determines available spectrum in a given geographic area that is not in use by other services (e.g., incumbents). It can also determine key cognitive radio (CR) operating parameters, such as transmitted power levels, occupied bandwidth, transmission timing, etc.

If properly implemented and administered, geolocation databases offer an opportunity for additional spectrum coordination, potentially on a near real-time basis. Not only can geolocation databases readily identify unused or under-utilized spectrum in a given area, but they can facilitate orderly co-existence among heterogeneous systems. The use of geolocation databases can abstractly be thought of as the “control channel” in cognitive radio systems, which coordinates multiple radios for the most efficient spectrum usage. This type of functionality is similar to the role that traditional frequency coordinators play in some bands, though likely on a more real-time basis. The database offers the opportunity for both the radio to flexibly adapt to the environment, as well as the database to adapt to the radio (as further described below).

There are several critical components of a database regime that must be addressed. The recommendations listed above provide a specific list of concerns that must be addressed when constructing and maintaining a database that will be employed as an interference avoidance technique. At the present time, various industries are beginning to focus on specific database issues. The recommendations presented above highlight many of the issues that have been encountered when attempting to construct and maintain a database in the context of the FCC TV white space proceeding. It is not intended to be an exhaustive list of recommendations. Specific issues relating to government spectrum, such as national security issues, may require additional consideration. The following discussion serves as a basis for some of the recommendations presented above.

³⁹ Executive Office of the President, National Economic Council and Office of Science and Technology Policy, “A Strategy for American Innovation: Driving Towards Sustainable Growth and Quality Jobs” (Sept. 2009).

⁴⁰ See FCC 08-260 “*Unlicensed Operation in the TV Broadcast Bands*”. Second Report and Order and Memorandum Opinion and Order, Nov. 14th, 2008. The FCC has recently accepted proposals from multiple database companies to provide TV white space database services.

⁴¹ See FCC open meeting presentation, “National Broadband Plan Policy Framework”, Dec. 16th, 2009.

3.3.1 Database Service Requirements

Though the application of geolocation databases is a relatively new field, the basic requirements for such services can be established. Database service requirements can be separated into two general categories: device requirements and database requirements. Nonetheless, both the device and database operations must work in concert in order to successfully avoid interference.

Cognitive radios that utilize database services must meet some basic requirements. First, the cognitive radios must have network connectivity to at least basic database services. This may be accomplished over traditional communications links (e.g., cellular data), backhaul links (e.g., wired internet connections), or through proxy devices (e.g., a master wireless device in a CR system). Second, the cognitive radios must have some type of geo-locating capability, such as any variety of GPS-based algorithms (e.g., GPS, or A-GPS), or several other location-determining algorithms (e.g., TDOA, AOA, etc.). Typically, a high degree of location accuracy is not critical for protecting large area networks.⁴² Indeed, a specific accuracy requirement may not be needed if the actual accuracy of each type of system is known and then added as a “safety margin” to the area where frequency use is forbidden. Thus systems with low accuracy would have fewer opportunities and designers would have a marketplace incentive to increase accuracy to improve performance. Furthermore, it is expected that cognitive radios (and the database service) will also possess detailed knowledge about the transmitter characteristics in the band (e.g., transmitter spectral masks/OOBE, occupied bandwidths, modulation types, antenna patterns, transmission timing, etc.). This type of information is generally shared in the system, but may be arbitrarily split between the devices and the databases.

Basic database services include, at a minimum, providing rudimentary information about other communications services operating in the band of interest. Rudimentary information typically includes service location (e.g., incumbent transmitter locations), radiated power levels, operating frequency and bandwidth, antenna pattern information, antenna height above average terrain, polarization, station call sign (or other identifying information), and service priority level. Additional information, such as transmission timing and modulation schemes may also be incorporated into the database, as described above. The incorporation of service priority levels allows intelligent planning for the band, and can be used to help determine orderly spectrum access. For example, while incumbent services (e.g., public safety and broadcast television) may have the highest priority level, other critical services (e.g., mission critical communications) may have the next highest priority level, while less critical services (e.g., consumer WLAN networks) may have lower priority levels. Such an approach allows critically important spectrum users to gain access to spectrum when most needed, such as during emergencies.

⁴² IEEE 802.22 proposed a CPE location accuracy requirement of 300m with 95% confidence.

Channel availability calculations may be performed using the above information about incumbent services and secondary (CR) devices operating in the band. The use of industry standard propagation models (e.g., FCC R6602 F-curves, ITU or Longley-Rice propagation models, etc.) can then be used to model the interference effects of a particular secondary CR system on the incumbents, and possibly on other secondary users in the system. This task can be accomplished with detailed knowledge of the interference rejection capabilities of the systems that are present.

Interference rejection specifications (e.g., co-, adjacent and alternate channel interference rejection ratios) are typically required for each system that is to be protected. For example, the ATSC A/74 specification provides recommended co- and adjacent channel DTV receiver performance levels that can be utilized to determine the amount of interference that secondary CR systems can generate before interfering with an incumbent DTV receiver.⁴³ Pre-defined incumbent protected service contours (e.g., grade B or Noise Limited Contours (NLC) for broadcast TV services) can be standardized. The protected service contours for incumbent services generally define areas where no secondary CR device co-channel operation is allowed, and adjacent channel operation may be allowed (e.g., at reduced transmit power levels), or may be prohibited.⁴⁴ For any given CR device operating location, these parameters along with signal propagation models can determine the maximum amount of power that can be radiated in a particular direction without exceeding the interference tolerance requirements of an incumbent system. Generally, detailed knowledge of both the transmitting and receiving devices present in the overall system is necessary.

3.3.2 Centralization or Decentralization of Database Information and Calculations

Recent trends, including the FCC TV white space decision, suggest delegating the database function to private entities. While the Commission has employed spectrum managers in a number of instances, mostly to administer homogeneous services, the database approach envisions a much broader role. Specifically, the database approach envisions using the database to provide near real time information regarding channel occupancy to a variety of potential disparate services. In effect, the database itself will be the key element in determining spectrum availability and which frequencies may be used without causing interference. Thus, accuracy of the database, as well as the correct application of this information by the devices relying on the database, is extremely important.

Database access is typically required to obtain channel availability information or the key operating parameters described above. Note, however, an issue arises as to whether the database functions (i.e., the computations that determine channel availability or maximum

⁴³ For example, FCC OET Bulletin 69 is also useful in determining incumbent broadcast receiver system performance assumptions.

⁴⁴ Note that the current TV white space operating rules may be modified in response to several Petitions for Reconsideration that were filed in the FCC 04-186 proceeding.

allowed transmission power levels) may be arbitrarily split between the CR and database functions. That is, the channel availability determinations may be centralized in one or more databases (as in the currently proposed rules for unlicensed device usage of the TV bands), or the computations may be performed in the CR devices themselves, with the rudimentary parameters about incumbent services provided by a database.⁴⁵ Some believe that the devices or independent third party entities should be authorized to calculate spectrum information in a decentralized fashion. For example, the device would calculate another device's protected contour based on information acquired from a database. This approach has the benefit of reducing the amount of query traffic to the database, especially for mobile devices. Note that CR device mobility can readily be supported using the same techniques described above.

Mobile CR devices are generally required to recompute their operating parameters (channel availability or maximum allowed transmission power levels) every time they move some minimum distance (e.g., 50 m). An alternative approach would be to centralize the computational function, and send the device a basic "vacant" or "occupied" notification. While the first approach relieves "query" burdens placed on the network, it is potentially less secure and more apt to lead to interference. In addition, decentralizing the computational process would make oversight more difficult as it may be done by devices or entities outside the government's control. Requiring a centralized approach has the advantage of ensuring that the correct spectrum information is uniformly distributed across all devices. If errors occur, they can easily be identified and resolved.

3.3.3 Limiting Database Access to Certified Devices

A fundamental issue arises regarding the types of devices that may use the database. For example, should the ability to use the database be limited to devices specifically authorized and certified by the FCC or NTIA? Absent such limitations, any device may be able to access such information, and because the device fails to meet specified certification requirements, it may cause interference. Such a result may undermine the underlying purpose of a database approach. The FCC, new users and incumbents may find it impossible to track down such potentially interfering devices. Limiting database access to FCC or government-certified equipment would allow such equipment to be verified and authorized.

Note that while the database function can be used as a rudimentary device authorization checking mechanism (by verifying that a particular device accessing the database has been authorized by the FCC or other regulatory agency), it is not a very effective means for controlling unauthorized access to a particular band. Unauthorized CR devices may simply bypass database access and transmit without regard to information in the database, perhaps through the use of spectrum sensing information. The information contained in the database is

⁴⁵ See FCC/OET 08-TR-1005 "Evaluation of the Performance of Prototype TV-band White Space Devices Phase II", Oct. 15, 2008. Motorola submitted a prototype White Space Device (WSD) to the FCC for the 2nd round of TV WSD testing, during 2008. The Motorola device relied on geolocation database calculations that were performed in the device itself, on an embedded processor, demonstrating the feasibility of the approach.

primarily used to benefit (i.e., protect) the incumbents and higher priority systems operating in the spectrum.

3.3.4 Other Considerations

Finally, note that the same database functionality can be used to protect and coordinate secondary CR systems operating in the band. One method of co-existence contemplated by the IEEE 802.19 group involves using the database to facilitate setting up additional shared control channels among secondary systems (e.g., via the Internet). More direct secondary system control may also be established through use of the database. For example, if secondary CR devices are required to report their current transmission parameters to the database (e.g., transmission channel, operating location, radiated power level, antenna height and pattern, etc.), the channel availability computations can additionally estimate the interference effects among the secondary systems, and provide coordinated spectrum usage on the “cleanest” communications channels for a particular area (somewhat like the traditional frequency coordinator function).

Furthermore, if spectral observations (i.e., CR device sensing measurements) are reported back to the database, the information can be used to check and possibly adjust the various signal estimates utilized by the database. The sensing information may also be utilized to verify the proper performance of the transmitters in the system (e.g., verify that the transmit spectral masks of low power TV transmitters are being met in the field).

The development of geolocation databases is clearly in its early stages, and many possibilities exist for actual implementations. Secondary unlicensed use of the U.S. TV bands will provide the earliest view of the possible database applications.

While DSA technology may be close to field deployment for some DoD applications, it remains to be “ported” to commercial applications (e.g., rural broadband Internet access, femtocells, cellular, etc.). Additional laboratory and field testing is required. This will require some investment of time and money. Also, some enabling technologies (like inexpensive multiband hardware) may not be readily available.

We also note that a milestone-driven coordinating group with the right mixture of senior people (decision makers and senior influencers) and funding does not yet exist. Domestically, the NTIA Federal advisory group is the Interdepartmental Radio Advisory Committee. This is a formal group that has been established to provide policy and technical advice to the NTIA related to spectrum management. The NTIA Office of Spectrum Management established a less formal group, DSA Coordination Group, where the agencies could discuss and exchange views on the diverse array of policy and technical issues associated with DSA, cognitive radio, and software defined radio. Because this is an informal group, industry representatives can and do participate. This group cannot make recommendations directly to the NTIA; however, consensus advice that is developed within the DSA Coordination Group could be submitted through the NTIA to the IRAC.

4. Harmonized Spectrum to Facilitate Grouping Services Recommendations

In the search to find additional spectrum and optimize spectrum allocations, policy makers must remain vigilant in realizing the benefits of promoting regional and/or globally harmonized spectrum allocations wherever possible. These benefits include:

- **Significant economies of scale in the development and deployment of both infrastructure and devices;**
- **Major enhancements to roaming across international borders;**
- **Enhanced interoperability among various services, devices and platforms.**

While recognizing these benefits, policy makers should also consider the potential impact of such harmonization on the development of new, innovative uses of spectrum and wireless technologies.

Discussion:

Harmonization should remain a principal consideration as spectrum managers consider how to address multiple demands on the spectrum resource. When realized, spectrum bands aligned on a regional (e.g. ITU Regions 1, 2 & 3) or global basis yield multiple benefits for end users, including lower device costs, service interoperability, and cost-effective international roaming possibilities. Another important benefit (to be addressed in the next section) stems from the fact that harmonization often anticipates the optimum clustering of services in the spectrum domain (as for example with 2.6 GHz TDD/FDD allocations).

One effort to quantify the impact of harmonization on handset costs and performance was conducted by U.K. consultant RTT in 2007. RTT examined the impacts of non-standard band allocations on the cost and performance of cellular handsets and by implication, the impact of RF device and design trends on spectrum allocation policy. RTT concluded that non-recurring engineering costs increase as the level of integration needed to accommodate non-standard spectrum bands increases. These costs are not volume dependent but, importantly, their recovery is – and across significant market volume. RTT further noted that present industry engineering resource constraints generally underestimate opportunity cost multipliers that significantly increase the real cost of cellular handsets intended for non-standard spectrum⁴⁶.

In addition to economic costs, roaming is another critical benefit derived from harmonization. The mobility inherent in wireless service has made global roaming a

⁴⁶ *RF Cost Economics for Handsets*, RTT (5 Sept. 2007, available for download at http://www.rttonline.com/home_frame.htm).

mandatory offering for most service providers. Should spectrum bands not be aligned across borders, then roaming can be difficult or impossible to achieve. Cost and size constraints place limits on the number of bands and technologies that typical small and low-cost consumer wireless devices can incorporate.

Moreover, harmonization aids countries that share borders in managing the potential for cross border interference. This is a critical consideration, for example, as countries within ITU Region 1 (including Europe and Russia) endeavor to harmonize the use of 800 MHz Digital Dividend frequencies so as to reduce the incidence of interference across national boundaries.

We note however, that excessive efforts towards harmonization may, in some instances, have the potential to discourage “disruptive” technical innovation by small innovative companies. Requiring multinational consensus in standards meetings held all over the world may be impractical for new entrants to effectively participate. Indeed, some note that CDMA technology was truly disruptive and made little progress in the consensus standards processes of the time. Accordingly, government policy makers may want to consider the potential impact of harmonization on development efforts of small companies.

5. Allocation Decisions: Sharing Like Services/Mixing Disparate Services

Policymakers must also strive to cluster like services when allocating spectrum wherever possible. Such clustering of like services is important because:

- **Clustering of like services is frequently a beneficial by-product of harmonized spectrum allocations.**
- **There is widespread consensus on the mechanisms and dangers of creating interference when licensing services that employ different duplexing technologies in adjacent spectrum. Careful attention is needed in such “boundary conditions” to avoid harmful interference.**

Some industry participants have noted that the problems associated with mixing disparate uses is illustrated in the plans to permit TDD operations in AWS-3 spectrum, without adequate allowances to protect adjacent AWS-1 FDD operations.

Discussion:

Harmonization often incorporates consideration of the optimal grouping of like/dislike services in a technologically neutral fashion. In some instances, however, technology neutrality may be misinterpreted to require abdication of optimal pairing schemes. A more appropriate interpretation is that technology neutrality requires that disparate services not be mixed.

This was one of the conclusions reached at the Silicon Flatirons Radio Regulation Summit (2009). Specifically, summit attendees (from academia, government, and industry) collectively expressed “support for clustering similar services to limit inter-channel interference conflicts.”

Recent spectrum decisions of the European Commission (EC) illustrate this point. For example, the EC’s allocation scheme for the 2.6 GHz band (illustrated below) facilitates coexistence by specifying for the separation of systems with disparate duplexing schemes (FDD v. TDD). However, the EC does not express views that a particular technology (e.g., WiMax v. UMTS v. LTE) should be deployed in specific parts of the band.

2500 MHz	2505 MHz	2510 MHz	2515 MHz	2520 MHz	2525 MHz	2530 MHz	2535 MHz	2540 MHz	2545 MHz	2550 MHz	2555 MHz	2560 MHz	2565 MHz	2570 MHz	2575 MHz	2580 MHz	2585 MHz	2590 MHz	2595 MHz	2600 MHz	2605 MHz	2610 MHz	2615 MHz	2620 MHz	2625 MHz	2630 MHz	2635 MHz	2640 MHz	2645 MHz	2650 MHz	2655 MHz	2660 MHz	2665 MHz	2670 MHz	2675 MHz	2680 MHz	2685 MHz	2690 MHz
UL 01	UL 02	UL 03	UL 04	UL 05	UL 06	UL 07	UL 08	UL 09	UL 10	UL 11	UL 12	UL 13	UL 14	TDD*										DL 01	DL 02	DL 03	DL 04	DL 05	DL 06	DL 07	DL 08	DL 09	DL 10	DL 11	DL 12	DL 13	DL 14	
FDD Uplink Blocks														FDD Downlink Blocks																								

Figure 13 – EC Allocation Scheme for 2.6 GHz

Similarly, the EC’s Wireless Access Policy for Electronic Communications Services (“WAPECS”) line of decisions (2007/09) provide for similar and minimal technology conditions to allow use of the spectrum for mobile, broadcasting and fixed services, on a technology and service neutral basis, subject to certain coexistence parameters to avoid interference. Coexistence concepts include both Block Edge Mask (“BEM”) and Restricted Blocks, as illustrated below.

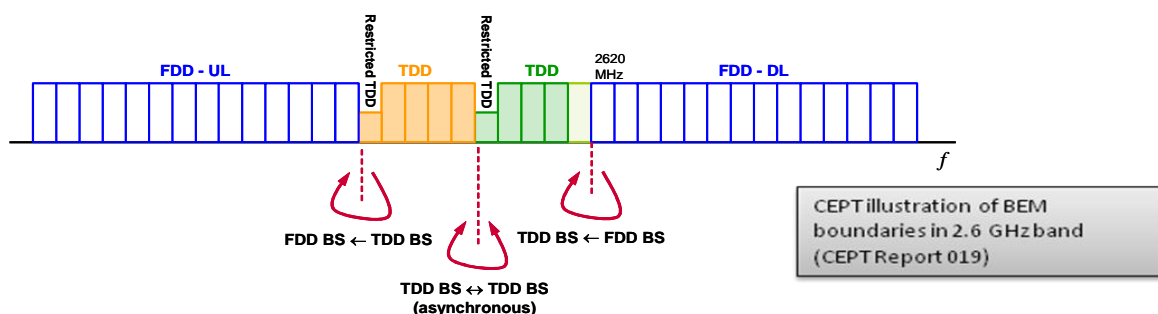

Figure 14 – CEPT Illustration of BEM Boundaries at 2.6 GHz

These clustering principles are intended to facilitate coexistence between coordinated and uncoordinated services and technologies. WAPECS is being implemented both with respect to 2.6 GHz auctions and in plans for assigning Digital Dividend spectrum.

6. Equipment Standards Recommendations

The NTIA, the FCC and other government spectrum managers should devote substantial resources to establish a wide-ranging evaluation process for new devices that use spectrum to transmit or receive signals. Increased demand for spectrum and the possibility of expanded sharing opportunities requires policymakers to focus on the importance of future receivers and transmitters as tools in achieving greater spectrum efficiency.

Historically, equipment standards have necessarily involved trade-offs between improved spectrum efficiency and consumer costs. Recent developments seem to indicate that new approaches may allow for the low cost production of receivers that are more spectrally efficient. A more detailed analysis of these technologies is needed. Accordingly, the following constitutes preliminary observations regarding an approach to equipment standards.

Government spectrum managers should consider incentives, rules and policies to:

- Improve the capability of receiving devices to reject adjacent channel interference.
- Improve devices to reduce the out-of-band emissions (OOBE) and adjacent channel interference from transmitting devices. Review existing OOBE regulations, including the $43 + 10\log P$ attenuation requirement as well as the Part 15 Section 209 Emission Limits, to ensure they provide sufficient protection when applied to new and varied services.
- Improve and reduce unintentional emissions from all electronic devices.

Investment in commercial and government communications services requires certainty that the equipment provided will not be subject to interference from new services sharing spectrum. Future spectrum planning must give consideration to the investment in existing legacy devices. Investment in equipment should not be stranded unnecessarily due to new services or devices that cause interference.

New services acquiring or accessing spectrum should be made aware of the interference characteristics of receiving and transmitting equipment operating on frequencies that will be shared or used in adjacent bands. The NTIA, the FCC or government entities responsible for managing spectrum should establish a clearinghouse to make such information available to those seeking to obtain spectrum access. Such information will give new services necessary visibility about the potential for interference for such equipment, before the new services access or bid for spectrum.

We recommend that the government fund research to accelerate development of monolithic radiofrequency (RF) filters (e.g., FBAR, MEMS) to improve selectivity, linearity and dynamic range of portable transceivers (e.g., LMR portables and cellular phones) without affecting size or power consumption. The ability to tune high-selectivity

filters and produce components in low volumes cost effectively should also be an objective of the funding. Thus a better dialog between the filter community and spectrum managers is essential as filter performance has a large impact on spectrum efficiency.

The NTIA, through the Institute for Telecommunication Sciences Laboratory (ITS), should characterize the unwanted emission levels of commercially available wireless devices and compare them to existing FCC standards to facilitate sharing with government users and to determine if changes should be made to the standards.

Technical improvements to transmitting and receiving equipment will permit greater spectrum sharing over time, as new generations of equipment come on line. When developing future spectrum sharing policies, spectrum managers should take into account changes and improvements in legacy equipment that will occur in the marketplace. While recognizing potential improvements in transmitting and receiving equipment, NTIA government spectrum managers should also consider the replacement rate of existing transmitting and receiving equipment, to avoid the potential for unnecessary stranded investment in this equipment. In doing so it should try to balance the costs of stranded investment with the public benefits of more spectrum access to both federal government and other users.

Discussion:

Over the years, government efforts to promote spectrum efficiency have focused primarily on the transmission side of the equation. Spectrum efficiencies have been obtained by regulating new and existing licensed services. Across all services, interference rules have focused generally on the power, height, and emission masks of these services. Thus, in the context of establishing specific service rules, the government has generally focused on technical rules affecting transmitters, both fixed and mobile.

While receiving equipment has been a consideration in spectrum decisions, the government has generally eschewed regulatory efforts to improve equipment quality. With the general increase in demand for spectrum dependent services, spectrum efficiency may no longer be a matter of establishing service rules for transmitting devices. Government policy may have to place greater emphasis on *receiving* equipment used in any communications ecosystem.

We suggest government spectrum managers should begin to explore a process that begins to examine both transmitting and receiving devices in the context of spectrum efficiency decisions. While the FCC certifies a variety of transmitting devices, including devices that share spectrum with government services, these case-by case-certifications do not generally focus on spectrum efficiency issues per se. For the most part, certification focuses on ensuring whether the device meets the parameters established in the FCC's service rule.⁴⁷

⁴⁷ Moreover, as discussed in Section 7, greater emphasis must be placed on enforcement. In this context, the current certification process may not be sufficient to insure that transmitting and receiving devices are spectrally
(continued on next page)

Government spectrum managers, including the NTIA and the FCC, must devote significantly greater resources to ensure new transmitting and receiving devices are efficient.

We recognize that this approach may require a shift in emphasis from current regulatory policies. Suggesting efficiency requirements for specific equipment is beyond the scope of this report. Indeed, depending on the equipment and the types of services and sharing, there may be a number of different approaches.

In this regard, we take note of OFCOM's examination of current and future receiver performance.⁴⁸ This report examined the costs vs. performance trade-offs involved in making receivers less susceptible to interference from other frequency bands based on technologies that may develop over the next ten or twenty years. The study notes that many of the cost vs. performance trade offs are changing with technology. For example, an integrated approach such as zero IF and low IF may allow the entire receiver to be fabricated in silicon. When manufactured in volume, the cost is very low and the performance improved.⁴⁹ However, such technology also negatively impacts receiver susceptibility to strong adjacent band signals since zero digital filtering is more subject to overload than physical front end filters.

The subcommittee believes that further research is necessary to properly evaluate this approach. Additional discussions with semiconductor vendors, manufacturers, service providers, retailers and consumer groups will be necessary to properly evaluate the costs and benefits of equipment standards in the context of a variety of spectrum sharing scenarios.

The following constitutes our preliminary observations on some of the basic issues that should be considered as we approach this issue:

Policies Should Stimulate Investment in New Equipment and Services: Increased emphasis on equipment will require government spectrum managers to balance competing interests. On the one hand, those investing in transmitting and receiving equipment, for both the government and commercial sectors, need technical certainty that this equipment will be not only approved, but will continue to operate free from interference for some period of time. As the demand for spectrum increases, there is a greater probability that interference will occur as more electronic devices share spectrum. To stimulate investment, service providers must have some certainty that their devices will continue to operate. To the extent interference issues arise, the new entrants should ensure that existing services are protected from harmful interference. Investment in legacy equipment should not be stranded, unless there is a

efficient. In addition, there appears to be no effective mechanism for recalling devices once in consumers' hands. This may be a significant problem in cases where there is no responsible licensee, and devices have been manufactured offshore.

⁴⁸ Davis, Lewis and Paul Winter, "Study of Current and Future Receiver Performance," OFCOM, January 11, 2010 (herein after *OFCOM Report*)

⁴⁹ *Id.* at 4

compelling public interest consideration. Such policies are applicable equally to commercial and government spectrum managers. Government spectrum users are often subject to budget constraints. In many instances, they are unable to acquire new equipment or afford implementing technical interference mitigation techniques. In some circumstances, mechanisms that allow new spectrum users to compensate government users for equipment upgrades may ease this problem and advance the public interest. In the commercial context, both communications service providers and consumers make significant investments in equipment. Spectrum managers and planners should recognize such investment and take them into account when making public interest determinations.

Building Equipment With “Interference Margins” May Be Problematic: Consistent with the principle stated above, we do not recommend requiring equipment suppliers to build in “interference margins.” An interference margin would require the equipment supplier and service provider to build current equipment to withstand potential interference from future services that may share the band.

While creating interference “margins” in equipment will increase the ability to share spectrum, such a policy may be too burdensome on equipment manufacturers. The consumer equipment market is highly competitive. Market imperatives generally do not support technologies or features that are not demanded by the public. Most equipment has been built to the “state of the art” within the context of these marketplace imperatives. Requiring additional “margins” for potentially new interference at some time in the future may cause a reduction in a device’s performance and increase costs. Such a policy may require receiver designers to include interference protection from unknown devices that may enter the band on a shared basis at some time in the future. Because the characteristics of a future device that would share the band would be unknown, it is not clear how a device manufacturer would be able to anticipate the types of interference that may or may not occur. As a result, such a policy may not only lead to unnecessary costs, but also may not protect against the specific type of interference that may arise at some future point in time.

Interference Characteristics of Legacy Devices Should be Made Known to New Users: In the past several years, new interference issues have arisen that were unforeseen by new entrants. In some instances, interference issues could have been avoided by providing the new entrant with the interference characteristics of receiving and transmitting equipment in adjacent bands. Knowledge of this equipment would give a new entrant sharing in-band or operating on an adjacent band, the opportunity to develop new equipment that mitigates the potential for interference with existing legacy equipment. Such advanced knowledge could avoid costly post deployment technical “fixes,” or delays in rolling out new services caused by last minute equipment redesigns.

To this end, we believe that NTIA and government entities responsible for spectrum management should consider creating an information clearinghouse. Such a database would contain information relating to the interference characteristics of equipment that is currently used on shared frequencies and also equipment used in adjacent bands.

Improvements in Technology: Some have expressed a concern that new technologies should not have to protect “substandard” existing equipment. They argue that protecting such

equipment will impede the development of new technologies. Others note that transmitting and receiving equipment is built to standards and operational parameters in the wireless environment, as it exists at that point in time. It would be unreasonable to call a device “substandard” from an operational standpoint simply because it was not built to operate in some future shared environment.

We believe it may be inappropriate to allow interference to occur based on a generic conclusion that new applications should not be required to protect substandard equipment. The concept as to what constitutes substandard equipment does not readily lend itself to precise standards. As a general matter, consumers or government spectrum users should not be denied the benefit of their purchases due to interference from a new entity.

Nonetheless, most industries have a recognizable churn rate as it relates to transmitting and receiving equipment. For some industries, consumer equipment may be replaced every 18 months. In other industries, such as broadcasting, and government uses, equipment lasts much longer. Government spectrum managers should consider this “churn” when assessing the ability of technology to avoid interference from new, shared uses. For example, it may be possible that over time, improvements are made to legacy equipment that will help reject interference from adjacent channels. In this regard, in some circumstances it may be inconsistent with the public interest to deny new spectrum sharing because of legacy equipment that was outdated or at the end of its reasonable life cycle. The public interest requires a balancing of interests here between incumbents with legacy equipment and the benefits of new spectrum use.

Alternatively, spectrum managers approving new sharing options may want to time the deployment of new services and devices to coincide with the next generation of legacy equipment. Such a policy would allow for legacy equipment to improve in a timely fashion and allow consumers to accrue the benefits of their purchase. We recognize that coordinating such deployment may be difficult and will vary from service to service. However, government spectrum managers should give such an approach significant consideration.

Revising OOB Standards: We recommend that government spectrum managers re-examine the Out of Band Emission Regulations now employed by the FCC. The OOB rules were generally developed in the context of very low power Part 15 Devices. Over the years, however, the number of electronic devices, licensed and unlicensed, now in use, has changed the RF environment. The Part 15 standards that may have prevented interference a decade ago may no longer be sufficient to prevent interference today. This is especially true where the government entities apply Part 15 OOB rules to higher-powered licensed or unlicensed devices. Thus, as the potential for sharing increases, government spectrum managers should review the OOB rules on a case-by-case basis to ensure there will be sufficient interference protection in today’s wireless ecosystem.

Both transmitter OOB performance and receiver susceptibility to adjacent band signals depends greatly on filter performance. Improving the dialog between the FCC, the NTIA and the filter technology community could benefit both groups. Some note that filter developers may be reluctant to commercialize high performance filters that do not have an immediate large market. A better dialog between filter developers and spectrum regulators

might be to expedite the introduction of better performance filters without the expenditure of limited federal R&D resources by creating markets for improved filters.

Again we wish to emphasize that these are preliminary observations on an extremely complex subject. Improvements in technology may significantly alter the cost vs. performance balance in the near future. Additional research is necessary to properly evaluate the equipment standards which will yield more spectrally efficient equipment.

7. Enforcement Recommendations

The NTIA, the FCC and government entities with spectrum management responsibilities need to shift from an interference prevention only approach to both prevention and rapid resolution of problems that occur. Enforcement will become an important aspect of making more spectrum available to meet growing demands and introduce new spectrum-dependant applications as sharing opportunities increase. But new spectrum applications may also uncover limitations on existing regulations that were unanticipated. Both need timely resolution to limit the resulting harmful interference.. These spectrum managers should:

- **Put in place streamlined interference reporting tools to complement “spot monitoring” of new operations.**
- **Increase penalties for violations. There should be a tiered series of penalties for violations of existing spectrum management rules that cause interference, with increased penalties, especially for incidents that put safety-of-life systems at risk.**
- **Increase budgetary resources for monitoring and enforcement. Budgetary funding should be increased to facilitate increased laboratory testing and field monitoring by the FCC and NTIA after new rules are implemented for advanced wireless technologies. Several sources of funding should be explored including an increase in Congressional appropriations, auction revenues or appropriate spectrum fees that are consistent with the cost of regulation.**
- **Per the FCC’s FY11 budget proposal language to resolve “100% of non-emergency interference complaints” in one month, the NTIA should encourage the Commission to expand this to a broader “shot clock” approach to responding to interference complaints so that licensees and operators of unlicensed devices will have certainty as to the timetable for concerns to be addressed.**
- **Develop tools for Temporary Restraint of Interference (TRI). Government entities responsible for spectrum management should establish a process, similar to a temporary restraining order, to address egregious interference complaints immediately. Upon a bona fide showing of interference from a specific device, class of devices or service, an entity receiving such interference**

should be able to file a complaint with the appropriate government agency. Upon an appropriate showing, the device or entity causing the interference shall cease such harmful transmissions, while the case is being examined by the appropriate government agency. This recommendation is not intended to alter the various spectrum priorities of existing law. For example, a device or service that is secondary in a band would lack standing to restrain an interfering device that has been given primary status.

- **Develop and explore the use of remote shut-off technologies for resolving interference problems. In cases where interference occurs, government spectrum managers, or government authorized frequency coordinators, should, upon a proper showing, and good faith attempt to notify, have the ability to remotely turn off transmitting equipment that is causing actual interference to other services.**
- **Increase assessments/Test-Bed approach. The ability of cognitive radio (software defined radio) technology to sense the surrounding RF spectrum environment can be harnessed to assist in reporting cases of “bad actors” in which nearby RF emitters are operating outside of their permissible parameters and causing interference.**
- **Equipment authorization will be an important tool in facilitating spectrally efficient equipment. It may be appropriate for the FCC and NTIA to review equipment authorization practices, such as spot checking, to ensure there are adequate and correct incentives to manufacture and distribute spectrally efficient equipment consistent with the FCC and NTIA rules.**
- **Establish a streamlined process for the maintenance and retention of interference reporting and enforcement data. Such data should include documentation of interference that may be caused by legally authorized operations. Analyzing these data will provide an ongoing assessment of FCC and NTIA spectrum management and enforcement policies.**
- **Explore through legislation, regulations or industry/government agreements, the ability of the federal government to expand its enforcement of spectrum interference rules, especially as it may relate to public safety and law enforcement.**

Discussion:

7.1 BACKGROUND

The FCC’s and NTIA's current regulatory regime is primarily focused on development of service rules and standards that *prevent* interference rather than on effectively addressing incidences of interference after the fact, with little attention on validating licensee or unlicensed operator compliance with applicable regulations regarding conditions of sharing.

Spectrum sharing arrangements – even when based on advanced technological capabilities – only are effective if incumbents’ operations have confidence that the rules of engagement will be enforced. *Post hoc* enforcement must become both more rigorous and meaningful to move beyond the current, complaint-driven process. This is critical in today’s regulatory environment and will become all the more important in the near future as there is an increased reliance on sharing options to obtain additional capacity for the increasing requirements of all spectrum users.

More flexible spectrum allocations, licensing and service rules increasingly place mobile advanced wireless devices and services – often operating at very low power levels – in close proximity to incumbent services in the same or adjacent spectrum. Because there is no truly “vacant” spectrum, this combination of increasingly congested spectrum and flexible regulations for sharing requires a move toward public policy on enforcement that is more proactive and less reliant on complaints. Complaints become a more flawed mechanism for highlighting interference concerns after new unlicensed devices have been deployed in the consumer market because the cause of the interference becomes harder to match to victim receivers.

Regulations governing expedited procedures for *post hoc* enforcement of interference are critical. A challenge is that the Commission’s and NTIA’s regulations continue to address this issue on a rulemaking-by-rulemaking basis and, typically, focus on preventing harmful interference on the front end of policy development instead of providing enforcement assurances post-deployment of new devices and applications. Moreover, such regulations should address long term enforcement issues. Over time there may be generations of DSA technologies operating in the same band within the same geographic area. To be effective such DSA technologies and enforcement procedures must be compatible across various services.

To address the growing importance of enforcement tools in this increasingly complex environment, this section makes recommendations about how Federal policymakers could improve measures at their disposal, including: 1) Streamlined enforcement and reporting; 2) Increased penalties for violations; 3) Increased budgetary resources for enforcement and related monitoring activities; and, 4) Test-Bed activity to support innovative ways of using new technology to improve enforcement efforts.

7.2 HISTORY

7.2.1 Factors to Be Addressed

The legacy of focusing on prevention more than enforcement points to the shortcomings of the present system, which raises several, inter-related issues that must be addressed:

Need for resources: Over time, budgetary resources have diminished the assets that the FCC and NTIA had to conduct active field monitoring of radio interference. (See Section III, (4)); the FY11 FCC budget proposal cites enforcement of spectrum management rules as a

performance objective. The budget request does not provide details on how resources would be increased to meet this goal.

A 2004 Government Accountability Office (GAO) report noted the last “compliance-type measurements” conducted by an NTIA monitoring van were in the mid-1980s⁵⁰. “These measurements were discontinued because of a lack of resources and generally low benefits provided to national spectrum management,” the report noted. “NTIA has also discontinued its broadband spectrum surveys—which covered the spectrum from about 100 MHz to 20 GHz. The last broadband survey measurements were made in the San Francisco area in 1995 with results reported in 1999.”

Need for Streamlining: Without fast-track processes for handling long-standing complaints, concerns about noncompliance may remain outstanding for years. One example was raised by Philip Weiser, in his 2009 paper, “FCC Reform and the Future of Telecommunications Policy,” with reference to complaints that satellite radio providers violated the terms of their licenses, regarding specifications for FM modulators and terms of Special Temporary Authorizations. He wrote “the FCC only took action and entered into a consent decree with the two companies once they were on the brink of receiving approval to merge with one another.”

As another example, a 2006 NAB study of Part 15 devices in the FM broadcast band pointed to widespread noncompliance, with less than 25 percent of devices tested meeting FCC field strength limits.⁵¹

Similarly, new technologies and other new developments create harmful interference situations that are legal but may need a generic rule correction to eliminate the problem. For example, some view the 1990’s NEXTEL/public safety problem as an example of interference that occurred even though the parties were operating consistent with the FCC rules. Similar issues appear to have occurred with the police radar detector/VSAT interference problem during the same period. In both cases, it took years before corrective policy changes were forthcoming to address these complex interference issues. Accordingly, the Subcommittee believes that a streamlined process for recording interference data should be created. This database will help government spectrum managers assess the efficacy of their spectrum management and interference policies.

⁵⁰ The GAO Report, “Lack of Knowledge and Varying Perspectives About Spectrum May Further Constrain the Use of More Spectrum Efficient Technologies,” said NTIA has the capability to capture knowledge to better understand the spectrum environment via a measurement program established in 1973 to assess whether spectrum is used in accordance with applicable regulations and provide data to prevent or resolve interference problems for federal systems. “However, the measurement program is limited to measuring and recording radio signals between 10 kHz and 20 GHz at selected sites through equipment housed in a single van and in portable suitcases. As such, the van has been used primarily to help reach consensus on difficult or unusual interference and spectrum sharing problems having a high national importance.” Examples cited were UWB and Broadband Over Powerline proceedings. The report noted in FY02, NTIA received \$2.1 million to replace the van; the replacement was used for the first time in 2003.

⁵¹ See NAB Submits Part 15 FM Modulator Device Study to FCC,” June 26, 2006.

Need to Address Increased Sharing Scenarios: Recent rulemakings to allow introduction of new spectrum-based technologies into or near bands in which potential interference to incumbents was a concern have addressed enforcement requirements, but have not elaborated on new ways of handling post hoc enforcement. Instead, the focus has been on structuring rules to mitigate the likelihood of interference on the front end.

Need to Address Different Needs of Different Users: Another challenge is that rulemakings governing enforcement mechanisms regarding spectrum sharing must reconcile the different impetuses that different users have for spectrum management in the first place – the profit-based drive of commercial spectrum operators versus the mission-based requirement of public safety, homeland security or national security users. In short, it is critical that enforcement regimes make interference an unprofitable enterprise (*See Recommendation 2, below*) and take into account the public interest-based requirements of government users that are harder to quantify from a market perspective.

Sharing is not static but is dynamic, as the actual number of devices deployed, applications used by consumers and technological advances developed for a shared band continue to evolve. This means the nature and type of interference concerns will change over time as well, both in the context of new technological developments potentially mitigating interference concerns or, alternately, altering the RF environment in a way that incumbents cannot quickly respond to mitigate new sources of interference.

Thus, enforcement policies must address this evolving dynamic of what shared use means in terms of real-world operations. This is particularly the case because the lead times of equipment procurement for government users (e.g., Federal users, local and state first responders) are often, due to budgetary planning cycles, far longer than commercial users, for whom equipment turnover occurs on a more rapid scale. In addition, this dynamic sharing environment means sharing rules increasingly should be considered by regulators as a two-way street, so that when a band has multiple users, flexible use is not restricted merely to new entrants.

Routine revisiting of how effectively sharing rules are working over time helps to relieve pressure on future enforcement efforts by addressing concerns about interference proactively and in a way that facilitates spectrum sharing for multiple types of users. A case in point is the extent to which the original bands set aside for Part 15 unlicensed use have, in some cases, become congested with less efficient legacy consumer equipment, causing innovative new applications for unlicensed spectrum to migrate to other bands. The converse is also important, legacy equipment in licensed bands may have difficulty sharing frequencies with expanding unlicensed operations.

7.2.2 Case Studies

Section 303(f) of the Communications Act, as amended, empowers the Commission to promulgate regulations necessary to prevent interference between radio stations as long as the rules are in the public interest.⁵² As the spectrum environment has grown increasingly complex, advanced technologies create new challenges for meaningful enforcement of the Commission's spectrum management rules. Recent FCC rulemakings, marked by protracted regulatory debates on the front end and enforcement uncertainty about interference on the back end, underscore why new sharing opportunities are often met with skepticism by incumbents.

UWB: In 2002, the FCC adopted rules that amended Part 15 regulations to allow the marketing and operation of ultra-wideband (UWB) devices.⁵³ After a protracted proceeding marked by disagreements among stakeholders on the emission levels needed to protect safety-of-life government systems and commercial operations, the Order incorporated standards to ensure UWB devices could operate in bands occupied by existing services while not causing interference.

The Order set different technical standards and operating restrictions for three types of UWB devices – imaging systems such as ground-penetrating radar, communications and measurement systems and vehicular radar systems – based on their potential to cause interference. “This combination of technical standards and operational restrictions will ensure that UWB devices coexist with the authorized radio services without the risk of interference while we gain experience with this new technology. In the meantime, we plan to expedite enforcement action for any UWB products found to be in violation of the rules we are adopting and will act promptly to eliminate any reported interference from UWB devices.” The *Second UWB Report and Order*, in 2004, indicated the FCC will “investigate any interference complaints from UWB devices to the authorized radio services, will take steps to ensure that interference is corrected, and will take whatever enforcement actions may be deemed necessary.”⁵⁴

In 2006, the Commission's Enforcement Bureau issued a Memorandum Opinion and Order that admonished Multispectral Solutions, Inc. (MSSI) for marketing in the United States unauthorized radio frequency devices in violation of Section 302(b) of the Communications

⁵² Section 302(a) of the Communications Act also authorizes the Commission, consistent with the public interest, to make reasonable regulations (1) governing the interference potential of devices which in their operation are capable of emitting radio frequency energy by radiation, conduction, or other means in sufficient degree to cause harmful interference to radio communications; and (2) establishing minimum performance standards for home electronic equipment and systems to reduce their susceptibility to interference from radio frequency energy.

⁵³ Ultra-wideband First Report and Order, ET Docket No. 98-153, rel. April 22, 2002.

⁵⁴ Ultra-wideband Second Report and Order and Second Memorandum Opinion and Order, ET Docket No. 98-153, rel. Dec. 16, 2004.

Act.⁵⁵ The Order noted the statute of limitations for issuing a Notice of Apparent Liability in the case is one year from the date of violation. The Bureau noted that, “[a]lthough we believe that a monetary forfeiture would be warranted for this violation, we note that MSSSI has not marketed the system in the United States since October 2005.”

TV White Spaces: In 2008, the FCC adopted rules to allow new wireless devices to operate in broadcast TV spectrum on a secondary basis at locations where that spectrum is not in use (the TV “White Spaces.”)⁵⁶ As was the case with the UWB proceedings, much of the reason that the development of the rules became protracted was due to contention about the risk of potential interference that the new devices could pose for incumbent operations. The rules stipulate that all devices (except for personal/portable devices operating in client mode) must carry a geolocation capability and be able to access over the Internet a database of protected services and the channels and locations that may be used by unlicensed devices at each location. (Unlicensed devices must access the database for a list of permitted channels before operating.)

The rules do not require a database administrator to resolve claims of interference from unlicensed TV band devices (TVBDs); but if there is a claim of interference, a database administrator, upon request from the FCC, must provide TVBD identifying information. The rules indicate: “If a device is found to be causing interference, the Commission may then require that the party responsible for the unlicensed device take corrective actions or cease operating the device until the interference is resolved. In addition, if a representative of the Commission attempts and is unable to contact the person responsible for a device that is determined to be causing interference, the Commission may require the TV bands database to return a message of ‘no channels available’ to the device at its next scheduled re-check.”⁵⁷ At the time, Commissioner Tate expressed concern that the rules did not include a “more specific and swift process to deal with complaints of interference. I remain concerned that the item is too vague and does not provide necessary protections after the interference has occurred.”

A further consideration involves not just introduction of new technologies, but mitigation or enforcement of interference when a spectrum operating environment changes and operators are complying with existing rules. (In other words, the rules themselves must change to prevent interference because they no longer reflect the requirements of the current RF environment.) The most obvious example of this scenario in recent years is that of Nextel purchasing specialized mobile radio (SMR) licenses in numerous markets and building these licensed areas into a national wireless network.

⁵⁵ Memorandum Opinion and Order, File No. EB-06-SE-372, rel. Dec. 14, 2006. The Bureau originally had responded to a complaint that the UWB receiver and processor hub in the company’s precision asset localization system had not been verified as required for Class A digital devices under Section 15.101(a) of the FCC rules.

⁵⁶ FCC Second Report and Order, Memorandum Opinion and Order, Unlicensed Operation in the TV Broadcast Bands, ET Docket No. 04-186, rel. Nov. 14, 2008.

⁵⁷ Id. Para. 212.

800 MHz Reconfiguration: Because Nextel and other wireless carriers shared 800 MHz spectrum with state and local public safety systems, interference problems arose when consumer wireless operations proliferated compared to the original SMR allocation in 1974, which was structured for a different set of technological circumstances and different patterns of use connected, initially, with taxi dispatch services. In 2004, the Commission approved a wide-ranging plan to reconfigure the 800 MHz band to address interference to public safety systems caused by Nextel's and others' high-density commercial systems using interleaved portions of the band. "The plan called for the separation and relocation of public safety and enhanced specialized mobile radio operators from interleaved spectrum assignments into an upper and lower band segments. In exchange for getting access to 10 MHz of spectrum in the 1910-1920 MHz band, the FCC required Sprint Nextel to relinquish certain spectrum holdings in the 800 MHz band and to cover incumbent relocation costs associated with moving public safety and industrial/business licensees to their new spectrum assignments."⁵⁸ The protracted length of time it has taken to address interference to public safety in this spectrum – both prior to and after the FCC's 2004 rebanding order – underscores the uncertainty that incumbent operators face in the current regulatory environment for having interference issues addressed in a timely fashion.

7.3 RECOMMENDATIONS

A more robust and fully funded regulatory enforcement regime for interference would not remove the requirement that new policies for effective spectrum sharing mechanisms get it right on the front end in terms of power limits, sensing requirements and other technical considerations to ensure interference to incumbent operations does not occur in the first place. A meaningful set of enforcement mechanisms would potentially expedite rulemaking processes that currently become mired in back-and-forth disputes regarding technical data and related evidence about the effectiveness of interference mitigation efforts. It would contribute to a greater culture of trust when it comes to sharing by ensuring there is a safety-net, if technical regulations are not complied with.

7.3.1 Streamlined Reporting/Enforcement

After promulgation of new spectrum sharing or flexibility rules, streamlined reporting tools should be put in place to complement "spot monitoring" of new operations. Routine reporting of localized interference incidents would help provide policymakers with an early warning system as to whether there are challenges in complying with the new rules or if regulations need to be revisited to ensure that interference is actually mitigated.

Streamlined reporting mechanisms should address the extent to which parties ultimately may take interference disputes to court, in which case resolution of claims could be protracted even further and potentially delay deployment of new technologies. So streamlined

⁵⁸ CSMAC Transition Report, December 2008.

enforcement should aim to short-circuit such scenarios, in part by increasing FCC and NTIA accountability for proactively addressing interference concerns vice the current system in which the onus is almost entirely on the person making the interference claim and seeking relief.

7.3.2 Increased Penalties for Violations

There should be a tiered series of penalties for violations of existing spectrum management rules that cause interference, with increased penalties, especially for incidents that put safety-of-life systems at risk. Particularly in the case of well-funded new entrants to a band that is opened for sharing, if enforcement is not financially significant, there are no meaningful deterrents from either ignoring interference concerns or, in a worst-case scenario for incumbents, using interference as a competitive tool for foreclosing competition in a band.

7.3.3 Increased Budgetary Resources for Monitoring and Enforcement

Budgetary funding should be increased to facilitate increased field monitoring by the FCC and NTIA after new rules are implemented. A 2009 National Academies of Science report on spectrum for science noted that among new techniques for interference control that “have been investigated by regulators but have not been acted upon” are improved enforcement technology to provide new tools for the regulators to ensure compliance with emission rules (e.g., commercial devices used for enforcement measurements, additional mobile measurement systems, etc.).

Sufficient resources to monitor compliance of new and other advanced wireless devices after spectrum sharing or flexibility rules have been implemented need not be “always on” monitoring but could consist of a series of spot-checks and trial monitoring in select bands and geographic locations to make initial assessments. More intense monitoring and testing could then focus strategically on patterns of non-compliance and particular “trouble spots.” Such assessments also could be conducted in coordination with voluntary monitoring undertaken by the private sector, in which government and commercial data was shared and was used as part of ongoing evaluations of real-world spectrum conditions.

The FCC budget request for Fiscal Year 2011 includes as a performance goal to “enforce the Commission’s spectrum regulations and policies,” by enforcing these rules to provide certainty to spectrum users “that they will not be subject to interference by the use of devices that do not comply with the Commission’s rules.” Related objectives that the budget request highlighted were to:⁵⁹

- Resolve 100% of non-emergency interference complaints within one month.
- Enforce FCC licensing and technical regulations, including limitations on power

⁵⁹ See FCC, FY 2011 Budget Estimates Submitted to Congress, February 2010.

outputs, antenna and tower height, and build-out requirements, to ensure licensees and operators of unlicensed devices are using spectrum efficiently and effectively.

- “Continue an aggressive program of inspections and investigations by agents in the field to help maximize compliance with the Commission’s licensing and technical requirements.”

Given the substantial capitalization of companies deploying new spectrum-based technologies that could potentially create interference in the absence of effective compliance, it is essential that the FCC be given adequate budgetary resources to carry out these enforcement objectives. Given the magnitude of stakeholder interests at stake, funding must back up these good intentions. Several sources of funding should be explored including an increase in Congressional appropriations, auction revenues or appropriate spectrum fees that are consistent with the cost of regulation.

7.3.4 “Shot Clock” Timelines for Addressing Interference

Per the FCC’s FY11 budget proposal language to resolve “100% of non-emergency interference complaints” in one month, the Commission should expand this to a broader “shot clock” approach to responding to interference complaints so that licensees and operators of unlicensed devices will have certainty as to the timetable for concerns to be addressed. Moreover, this “shot clock” approach should be extended to government users as well as, so that all incumbents in a band that is shared will face a level playing field in terms of interference being routinely addressed in an expedited fashion. Such clarity on timing could provide as strong a deterrent as financial penalties.

7.3.5 Increased Assessment/Test-Bed Approach

The ability of cognitive radio/software defined radio technology to sense the surrounding RF spectrum environment can be harnessed to assist in reporting cases of “bad actors” in which nearby RF emitters are operating outside of their permissible parameters and causing interference.

In the case of a TV white space configuration, for example, such policy-based protocols could be used to report this information to a database administrator. The advantage of this would be allowing interference issues to be addressed proactively, rather than relying on complaints from incumbents. We would recommend a Test-Bed approach to ascertain the extent of current technological capabilities to fulfill this regulatory objective.

7.3.6 Monitor Deployment of Systems Employing Opportunistic Sharing Techniques

Currently, when a device is certified, the output of the device is tested in response to a single or limited number of input conditions, to verify that it complies with the FCC’s rules. However, for devices employing opportunistic sharing techniques such as DSA, it will be necessary to test the output of the device in response to various inputs or various combinations

of inputs. In the case of DSA, the compliance measurements would verify parameters such as the detection threshold, startup and in-service monitoring times, the time to cease transmissions or move to another channel, and the time to revisit a portion of the spectrum to determine whether or not it is unoccupied. Even with this relatively simple implementation of an opportunistic sharing technique, developing compliance measurement procedures proved to be challenging. Systems employing opportunistic sharing techniques can be very complex employing spectrum sensing, geolocation and other capabilities to protect incumbent users. NTIA should work in conjunction with the FCC to monitor the deployment of systems employing opportunistic sharing techniques. After devices are certified by the FCC and sold to the public, the NTIA should acquire samples of these devices and perform independent measurements to verify they comply with the FCC service rules. Monitoring these devices early in the process is critical to resolve any problems before widespread deployment occurs.

These recommendations are substantiated by research and analytical efforts undertaken in the last several years that point to a need for more enforcement resources to facilitate the deployment of advanced technologies that contribute to the increased complexity of the current spectrum environment.

As Victor Pickard and Sascha Meinrath noted in their 2009 paper on “Revitalizing the Public Airwaves: Opportunistic Unlicensed Reuse of Government Spectrum,” “It should be noted that there are well-founded concerns about interference and other potential drawbacks with spectrum-sharing schemes.” Citing an earlier paper by Phil Weiser and Dale Hatfield, they indicate the FCC should continue moving ahead to implement different proactive and reactive measures that will provide users of commons access spectrum with important assurances that new services and products will not be compromised either by bad actors or poor coordination.

Spectrum Policy Task Force: FCC’s Spectrum Policy Task Force Report in 2002 noted: “The Task Force believes that in order for the Commission to be able to meet the increasingly complex spectrum management demands being presented by the enormous growth in spectrum use, the Commission must devote sufficient resources to monitoring spectrum use and enforcing the spectrum management rules.” The report recommended the FCC examine its field offices’ and monitoring facilities’ needs and consider additional funding and resources to accommodate such recommendations. The Task Force said the FCC also “may want to seek a review and possible increase in its statutory forfeiture authority in order to provide additional incentives for spectrum users to comply with the Commission’s rules.”⁶⁰

Wireless Innovation NOI: The FCC’s Wireless Innovation and Investment Notice of Inquiry posed a series of questions about interference protection, mostly focusing on issues such as how to assess conflicting concerns during the rulemaking process, asking: “how should we address interference issues that may arise after a service is deployed if all parties may be operating consistent with the rules?”⁶¹

FCC Reform Proposals: This lack of enforcement focus with respect to spectrum interference also has been addressed in the broader context of FCC reform. Philip Weiser, in his 2009 paper, “FCC Reform and the Future of Telecommunications Policy,” wrote that on a foregoing basis, the Commission has a critical opportunity to invigorate its enforcement program and use it more strategically:⁶²

“The FCC needs to develop a better capability for enforcing its rules in a credible manner so that it can, in appropriate instances, shift from its legacy focus on restricting what parties can do before-the-fact to evaluating the impact of actual behavior after-the-fact. In the case of spectrum policy, for example, the FCC’s legacy orientation means that spectrum licensees are restricted in how they can use their spectrum so that they avoid even the theoretically possible creation of interference—as opposed to making a showing that they created interference in practice.”

Concerns Over Passive Systems: A 2009 national Academies of Science Report, *Spectrum Management for Science in the 21st Century*, pointed to the cumulative impact of widely deployed devices on passive systems: “Since RFI in EESS (Earth Exploration Satellite Services) operations is cumulative, there is no protection from the impact of a high density of low level transmitters resulting from strong market penetration of unlicensed products.” The Report noted with respect to regulatory enforcement, that current measures “are primarily by licensee self enforcement or by the FCC’s use of a limited number of mobile interference monitoring laboratories (seven in the US). The proliferation of mobile wireless transmitters within consumer, commercial and government systems require new monitoring and enforcement technologies.”

CSMAC Recommendations: The need to shift from interference prevention to both prevention and enforcement increases as sharing opportunities become an important aspect of making more spectrum available for new spectrum-dependent systems, services and advanced wireless applications. CSMAC Working Group 2 recognized this in a 2008 report on Federal and non-Federal spectrum sharing: “Post hoc enforcement of interference should be established as part of streamlined sharing arrangement to provide mutual certainty between users as to how such concerns would be addressed, particularly when complainants may seek relief from different regulatory bodies (e.g. FCC vs. NTIA).”

V. CONCLUSION

As the demand for spectrum increased, there will be increased pressure on policy makers to develop new approaches to sharing spectrum. The purpose of this Report is to focus on the complex technical issues associated with increased spectrum sharing. In many respects, the interference polices pursued by government agencies responsible for spectrum management will have a significant impact on the development of new spectrum technologies. These policies will also affect investment incentives in spectrum-based communications services.

We have attempted to highlight specific issues that need to be addressed by the full committee. In some areas, additional research will be necessary to develop the appropriate policies that will stimulate new communications services, avoid the disruption of incumbent services and fully utilize this nation's spectrum assets.